

DISTRIBUIDOR AUTORIZADO.  
www.imservo.com  
ventas1@imservo.com / ventas2@imservo.com  
QUITO-GUAYAQUIL  
ECUADOR



**XINJE**

# **XC series extension BD board**

**User manual**

WUXI XINJE ELECTRIC CO., LTD.

Data No. PC14 20111202 3.3

# Catalog

1. Configure method of BD board .....	5
1.1 BD configuration .....	5
2. XC-2AD2PT-BD.....	6
2.1 Characteristic .....	6
2.2 General Specification.....	6
2.3 Wiring .....	7
2.4 Input address .....	7
2.5 Working mode.....	7
2.6 Control specification.....	9
2.7 Application of PID output.....	10
2.8 Program.....	10
3. XC-2AD2DA-BD .....	12
3.1 Characteristic .....	12
3.2 General Specification.....	12
3.3 Wiring .....	13
3.4 Input address.....	13
3.5 Working mode.....	14
3.6 AD transformation diagram .....	16
3.7 Example .....	16
4. XC-4AD-BD .....	18
4.1 Characteristics.....	18
4.2 General specifications.....	18
4.3 Wiring .....	19
4.4 I/O address assignment .....	19
4.5 Working mode.....	19
4.6 The application of PID output.....	21
4.7 Programming .....	21
5. XC-COM(-H)-BD.....	23
5.1 Characteristic .....	23
5.2 Wiring .....	23
5.3 XC software setting .....	23
6. XC-SD-BD .....	25
6.1 Characteristic .....	25

6.2 Explanation .....	25
6.3 Operation for the SD .....	26
6.4 SD card state information ID1000 .....	28
6.5 The type definition in “.csv” file .....	29
6.6 Install and set the BD board .....	29
6.7 Format changing tool .....	31
6.8 Example .....	32
7. XC-TBOX-BD .....	38
7.1 Summarization .....	38
7.2 Characteristics .....	38
7.3 System construction .....	38
7.4 Suitable field .....	38
7.5 Interface for Ethernet .....	39
7.6 Configure the BD board .....	40
7.7 DIP switch .....	40
7.8 LED display .....	41
7.9 Using steps .....	41
7.10 Connect to SCADA .....	45
7.11 Application .....	49
8. XC-WT-BD .....	55
8.1 Summarization .....	55
8.2 Specifications .....	55
8.3 Terminals .....	56
8.4 Weighing system .....	56
8.5 BD Configuration .....	57
8.6 Pressure sensor .....	57
8.7 A/D transformation diagram .....	58
8.8 I/O address .....	59
8.9 Programming example .....	59
9. XC-OFC-BD .....	60
9.1 Summarization .....	60
9.2 Installation and wiring .....	60
9.3 Configuration and settings .....	62
10. XC-PBOX-BD .....	64
10.1 Summarize .....	64
10.2 Terminal resistor .....	64
10.3 Installation and configuration .....	64

10.4 Wiring ..... 66  
10.5 DIP switch..... 67  
10.6 LED..... 67  
10.7 Operation steps ..... 67



## 2. XC-2AD2PT-BD

### 2.1 Characteristic

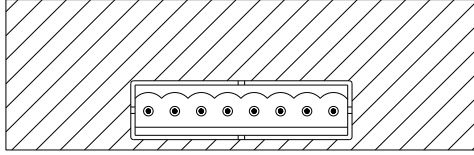

- 14 bits high precise analog input.
- 2 channels voltage 0~10V, 0~5V selective, 2 channels temperature analog input.
- Platinum temperature testing resistor (Pt100 two-line format), temperature sensor using analog input.

### 2.2 General Specification

Item	Voltage input	Temperature input
Analog input signal	DC0~5V, 0~10V (Input resistor 13.3kΩ)	Platinum resistor Pt100 (2-line format)
Temperature testing bound	-	-100~350°C
Distinguish ratio	0.15mV (10/16383)	0.1°C
Digital output bound	0~16383	-1000~3500
Colligate precision	±1% of the full-scale	
Convert time	15ms×4 channels	
PID output value	0~K4095	
No-load defaulted value	0	3500
Input characteristic		
Insulation	No insulation between each channel of PLC	
I/O engross	0 I/O (Since it is operated via data register, so it is not limited by main PLC's standard max. control points)	

## 2.3 Wiring

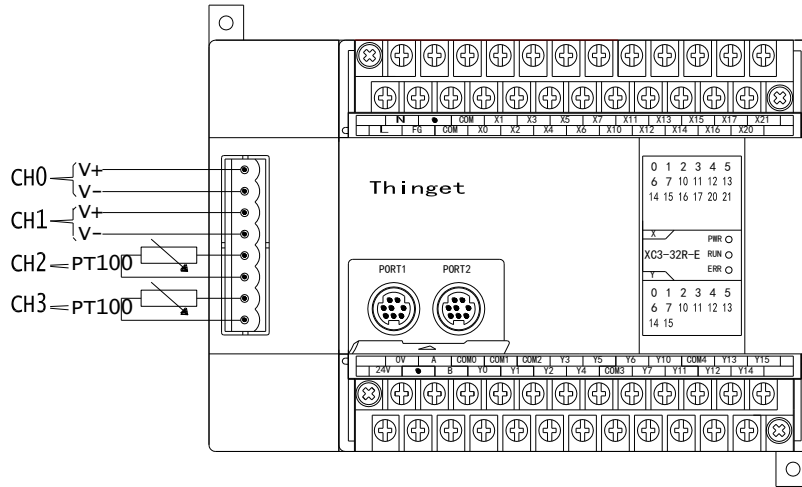

## 2.4 Input address

This BD board doesn't occupy any I/O unit, the converted value will be sent to PLC register directly, the corresponding PLC registers address:

Channel	AD signal/ temperature	PID output value	Set data/temp -erature	Kp	Ki	Kd	Diff	Death	start/ stop
0CH	ID1000	ID1004	QD1000	QD1004	QD1005	QD1006	QD1007	QD1008	Y1000
1CH	ID1001	ID1005	QD1001						Y1001
2CH	ID1002	ID1006	QD1002	QD1009	QD1010	QD1011	QD1012	-	Y1002
3CH	ID1003	ID1007	QD1003						Y1003

### Description:

- 0CH, 1CH are AD input channels; 2CH, 3CH are Pt input channels.
- Kp: proportion parameters; Ki: integral parameter; Kd: differential parameters; Diff: control range  
Control range Diff: in the assigned range, carry on PID control, beyond that range, don't carry on that control

Start signal (Y): if Y is 0, close PID control, if Y is 1, start PID control.

Death range (Death): it means the current PID control value compares with the preceding PID control value, if the difference between them is less than the set range of death, the module will abandon the current PID control value, send the preceding PID control value to the PLC main unit.

## 2.5 Working mode

There are two ways to set the working mode.





00: 1/2 filter		0:0~10V		00: 1/2 filter		0:0~10V	
01: not filter		1:0~5V		01: not filter		1:0~5V	
10: 1/3 filter	-			10: 1/3 filter	-		
11: 1/4 filter		-		11: 1/4 filter		-	
Channel 3				Channel 2			
Bit15	Bit14	Bit13	Bit12	Bit11	Bit10	Bit9	Bit8
00: 1/2 filter				00: 1/2 filter			
01: not filter		-	-	01: not filter		-	-
10: 1/3 filter				10: 1/3 filter			
11: 1/4 filter				11: 1/4 filter			

## 2.6 Control specification

1. Functions of the four parameters: proportion parameter (Kp), integral parameter (Ki), differential parameter (Kd), control proportion band (Diff).

Parameter P is proportion parameter. It shows the difference of system. It can control the difference once it produced.

Parameter I is integral parameter. It can delete the offset and improve the accuracy.

Parameter D is differential parameter. It can control the changing trend of signal and decrease the system oscillation.

Temperature control range: do PID in the range.

### 2. Control specification

The PID control range is from QD-Diff to QD+Diff. When the temperature is less than QD-Diff, the controller heats up; when the temperature is higher than QD+Diff, the controller stops heating.

Temperature-control curve of PID:

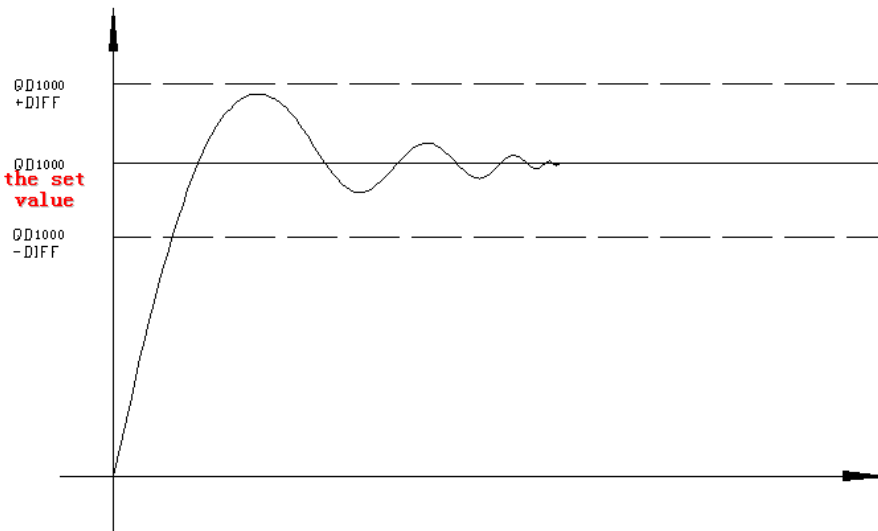

3. Each parameter's reference value:  $K_p=20\sim100$ ;  $K_i=5\sim20$ ;  $K_d=200\sim800$ ;  $DIFF=100\sim200$

These values are for your reference. Please adjust them as the actual needs.

### 2.7 Application of PID output

The module output a PID value every 2s when it is doing PID temperature control. It can control the heating process in the following way. Suppose the PID output value is  $X$  ( $0\leq X\leq 4095$ ), the controller will heat in  $2X/4095$  seconds, the controller will not heat in  $(2-2X/4095)$  seconds.

### 2.8 Program

1. real-time read channel 0 AD value, set the channel 0 PID parameters, read the PID output.

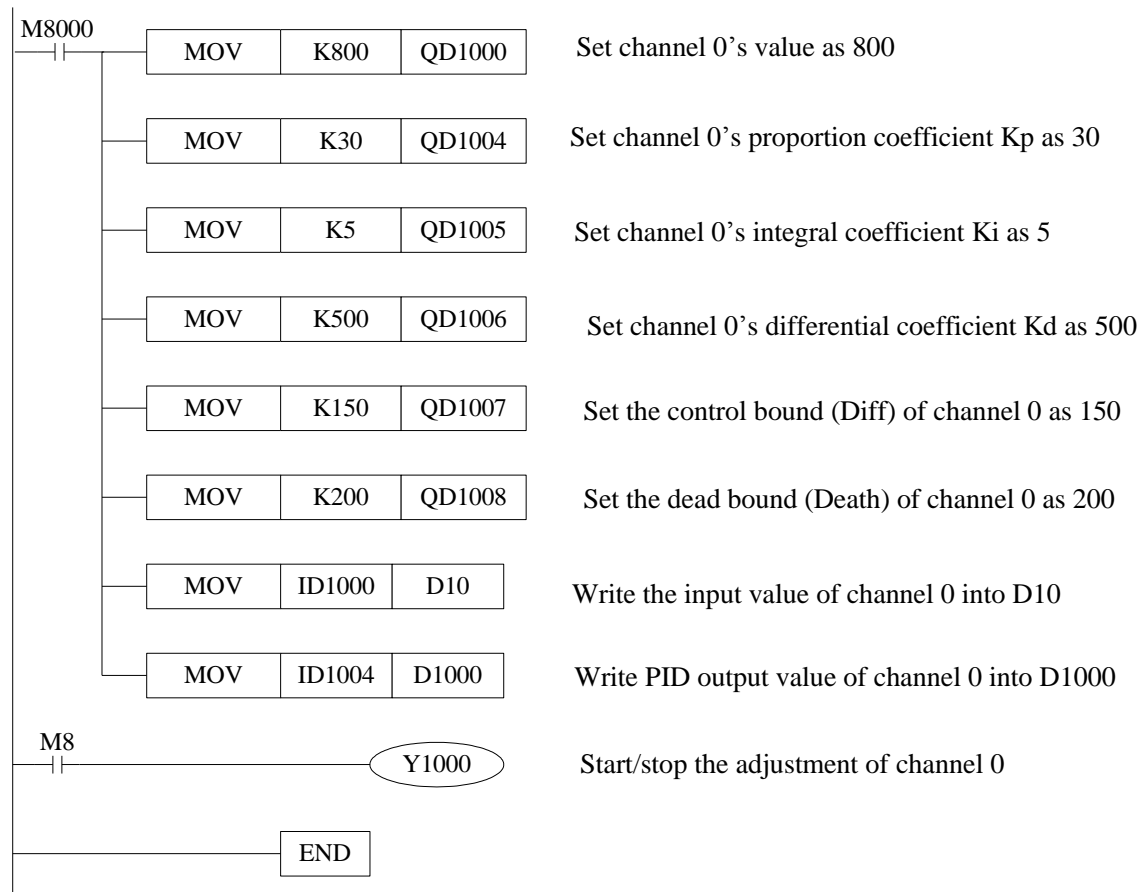

## 2. PID temperature control

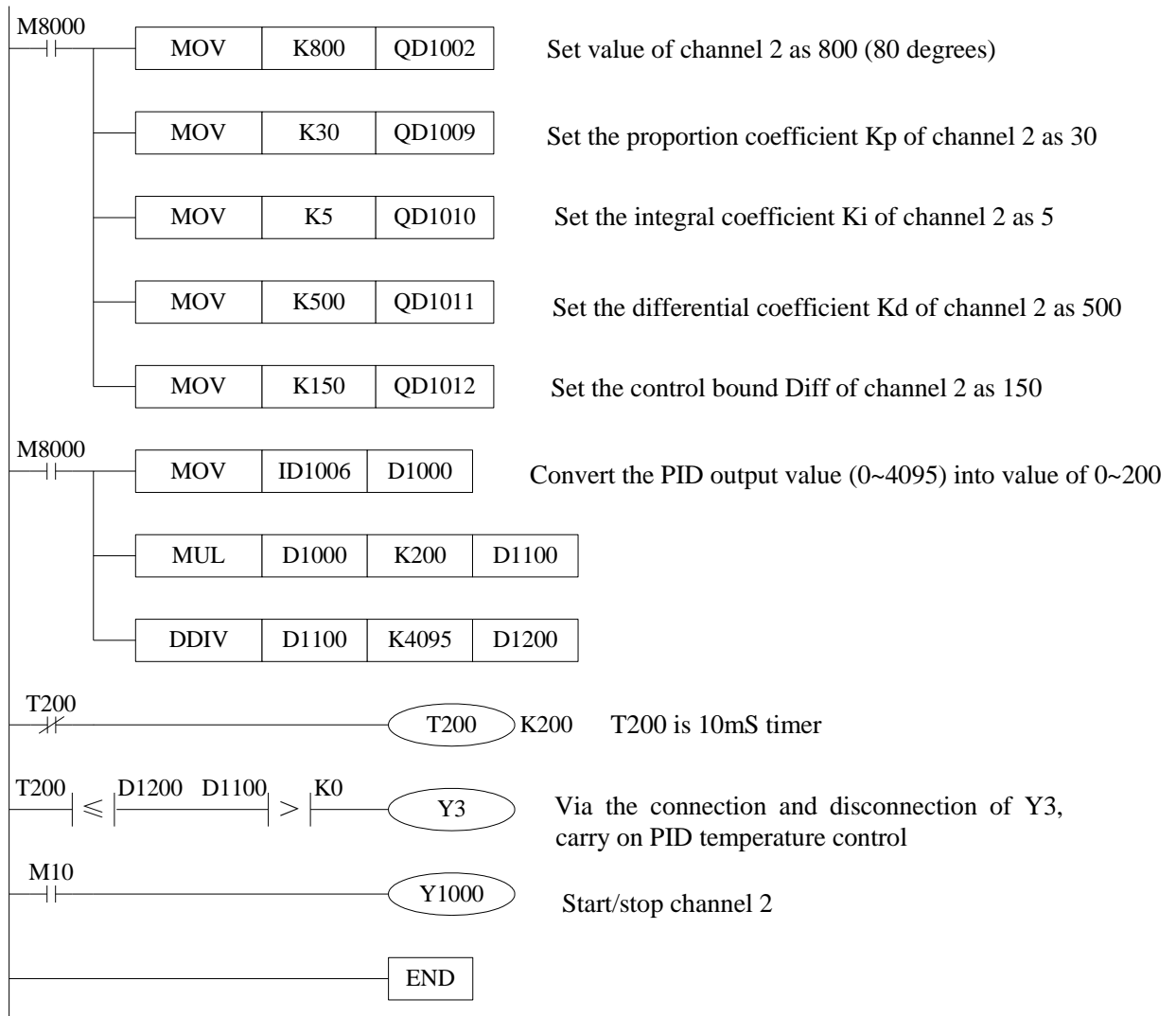

### 3. XC-2AD2DA-BD

#### 3.1 Characteristic

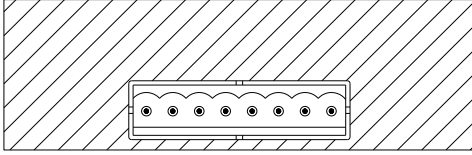

- 14 bits high precise analog input.
- 10 bits high precise analog output
- 2 channels 0~10V, 0~5V voltage input
- 2 channels 0~20mA, 4~20mA current output

#### 3.2 General Specification

Item	Voltage input	Current output
Analog input range	DC0~5V, 0~10V (Input resistor 13.3kΩ)	-
Analog output range	-	DC0~20mA, 4~20mA (external load resistor less than 500Ω)
Resolution	1/16383 (14 bits); the transformed data are stored in PLC in hex format (14 bits)	1/1023 (10 bits); the transformed data are stored in PLC in hex format (12 bits)
Digital output range	14 bits binary (0~16383)	-
Digital input range	-	10 bits binary (0~1023)
Colligate precision	±1% of the full-scale	
Convert time	15ms×2 channels	3ms/1 channel
PID output value	0~K1023	-
Insulation	No insulation between each channel of PLC	
I/O engross	0 I/O (Since it is operated via data register, so it is not limited by main PLC's standard max. control points)	

### 3.3 Wiring

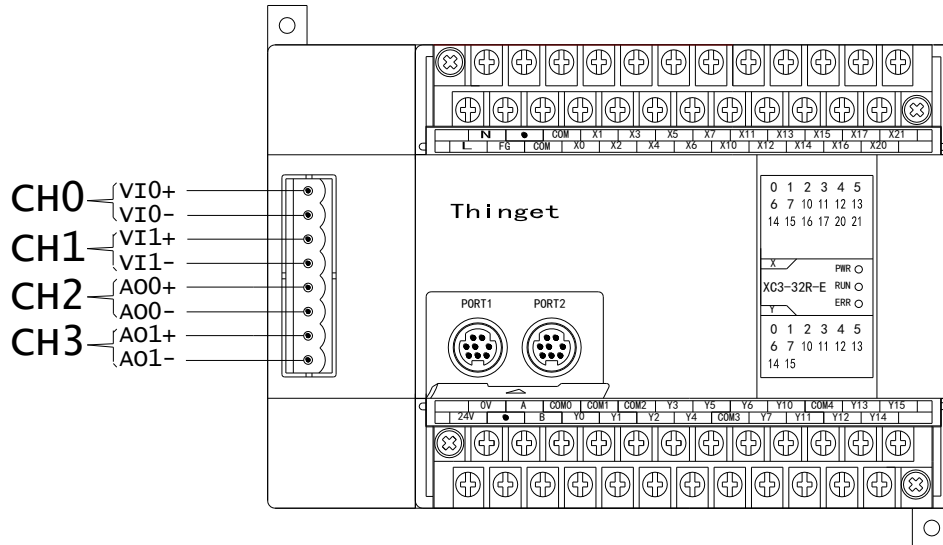

XC-2AD2DA-BD needs 24V power supply for current output.

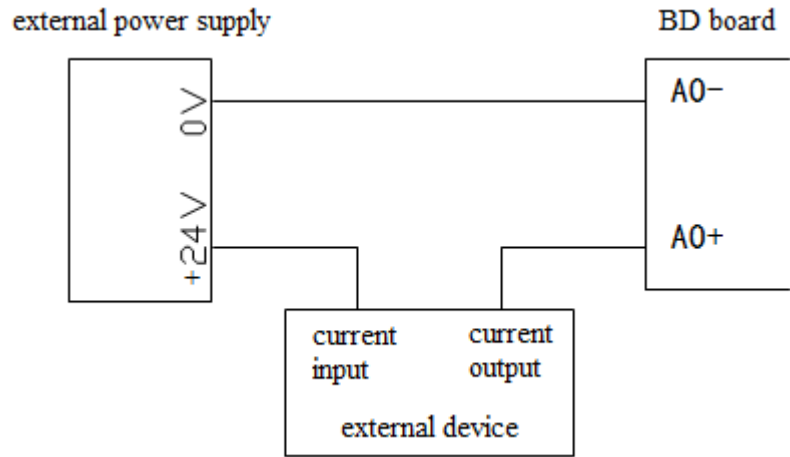

### 3.4 Input address

This BD board doesn't occupy any I/O unit, the converted value will be sent to PLC register directly, the corresponding PLC registers address:

Channel	AD signal	PID output	PID start/stop bit	Set value	PID parameters: Kp, Ki, Kd, Diff, Death
0CH	ID1000	ID1002	Y1000	QD1002	Kp-----QD1004; Ki-----QD1005;

1CH	ID1001	ID1003	Y1001	QD1003	Kd-----QD1006; Diff---QD1007; Death--QD1008
Channel	DA signal	-	-	-	-
0CH	QD1000	-	-	-	
1CH	QD1001	-	-	-	

**Description:**

- 0CH, 1CH are AD input channels; 2CH, 3CH are DA output channels.
- Kp: proportion parameters; Ki: integral parameter; Kd: differential parameters; Diff: control range  
Control range Diff: in the assigned bound, carry on PID control, beyond that range, don't carry on that control

Start signal (Y): if Y is 0, close PID control, if Y is 1, start PID control.

Death range (Death): it means the current PID control value compares with the preceding PID control value, if the difference between them is less than the set range of death, the module will abandon the current PID control value, send the preceding PID control value to the PLC main unit.

**3.5 Working mode**

There are two ways to set the working mode.

- Set through the XCPpro software
- Set through PLC register FD

- Set through XCPpro software

Open the XCPpro software, connect it with PLC and BD. Click configure/BD setting to open the BD set window.

Click "other BD" and choose the BD model and set the working mode. Then click ok and restart the PLC.

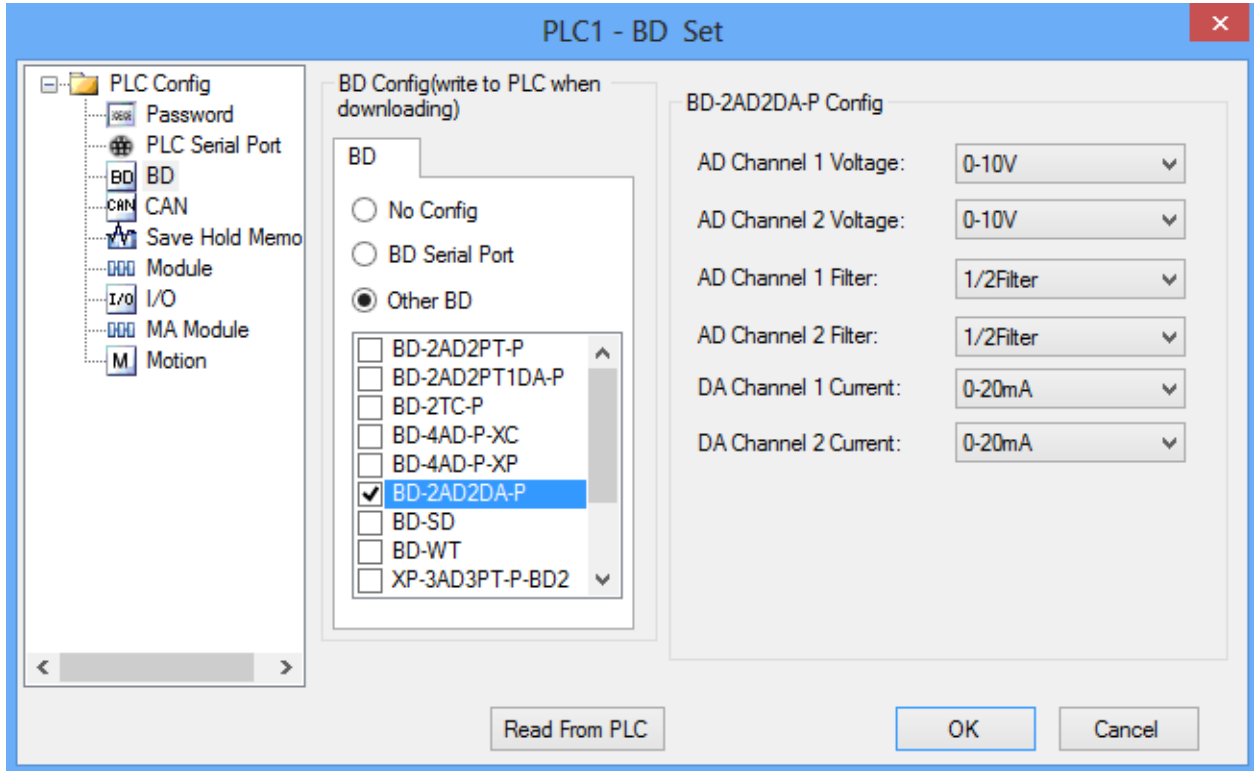

- Set through PLC register FD

The expansion BD board has 0-5V, 0-10V voltage input and 0~20mA, 4~20mA current output. The working mode can be set through FD register. Please see the below picture.

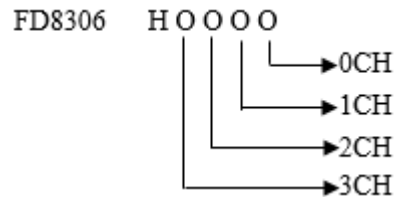

One register has 16 bits, every 4 bits can decide one channel's working mode.

Register FD8306:

Channel 1				Channel 0			
Bit7	Bit6	Bit5	Bit4	Bit3	Bit2	Bit1	Bit0
00: 1/2 filter		-	0: 0~10V	00: 1/2 filter		-	0: 0~10V
01: no filter			1: 0~5V	01: no filter			1: 0~5V
10: 1/3 filter		-	-	10: 1/3 filter		-	-
11: 1/4 filter			-	11: 1/4 filter			-

Channel 3				Channel 2			
Bit15	Bit14	Bit13	Bit12	Bit11	Bit10	Bit9	Bit8
-	-	-	0: 0~20mA 1: 4~20mA	-	-	-	0: 0~20mA 1: 4~20mA

### 3.6 AD transformation diagram

The relationship between input analog and transformed digital data:

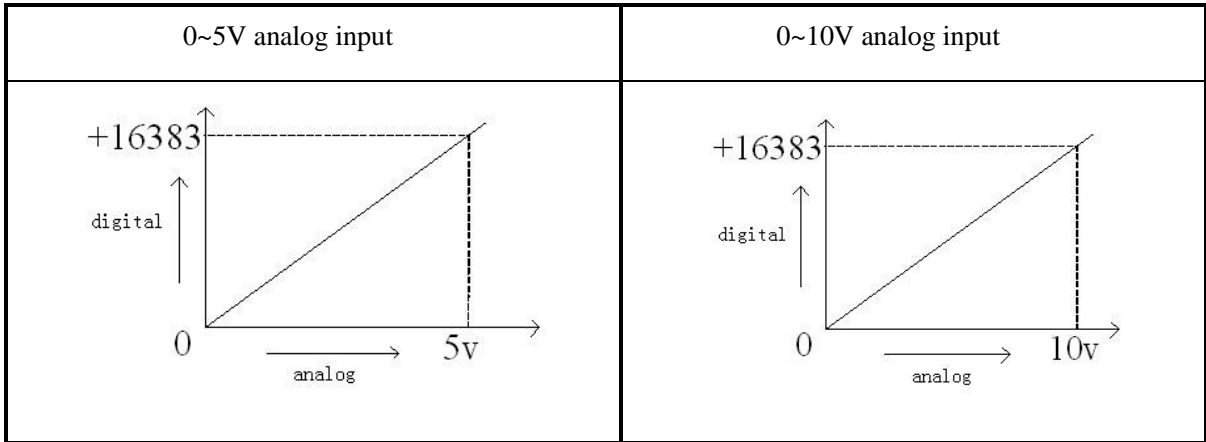

The relationship between input digital and transformed analog data:

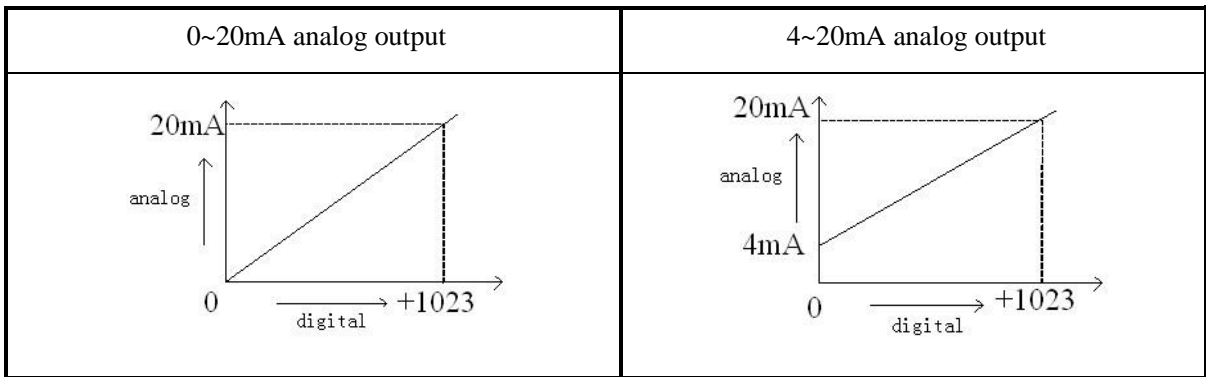

**Note:** If the input data is more than K1023, D/A result will be 20mA.

### 3.7 Example

Read the real time data of 2 channels; write the data in 2 channels.



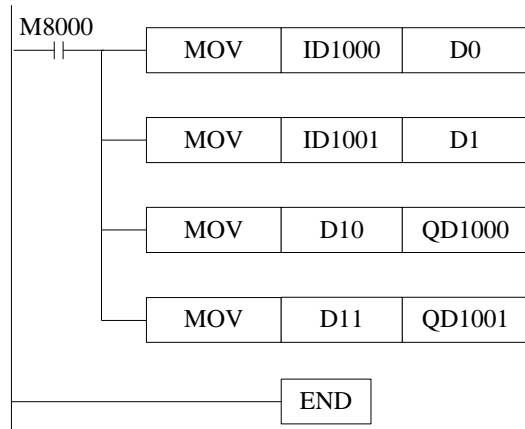

**Explanation:**

M8000 is always ON when PLC is running.

When PLC is running, it sends the channel 0 data of model 1 to register D0 of PLC.

It sends the channel1 data of model 1 to register D1 of PLC.

It sends the PLC D10 data to model 1 channel 0.

It sends the PLC D11 data to model 1 channel 1.

## 4. XC-4AD-BD

### 4.1 Characteristics

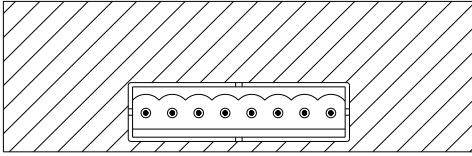

- 14 bits high precision analog input
- First 2 channels 0-10V, 0-5V voltage input choices
- Last 2 channels 0-20mA, 4-20mA current input

### 4.2 General specifications

Item	Voltage input	Current input
Analog input range	DC0~5V, 0~10V (Input resistor 13.3kΩ)	0~20mA, 4-20mA
Resolution	1/16383 (14 bits);	
Digital output range	14 bits binary (0~16383)	14 bits binary (0~16383)
Colligate precision	±1% of the full-scale	
Convert time	15ms×4 channels	
PID output value	0~K4095	
Default value of free load	0	
Input features		
Insulation	No insulation between each channel of PLC	
I/O engross	0 I/O (Since it is operated via data register, so it is not limited by main PLC's standard max. control points)	

### 4.3 Wiring

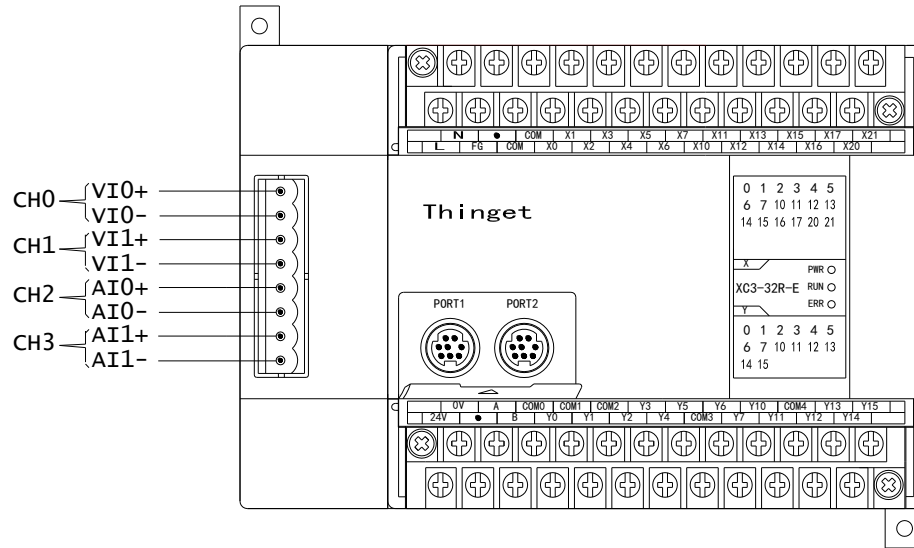

### 4.4 I/O address assignment

The BD board will not occupy I/O space, the transformed data will be saved in PLC registers. The PLC registers are as the following:

Channel	AD signal	PID output	PID control bit	Set value	PID parameters: Kp, Ki, Kd, Diff, Death
0CH	ID1000	ID1004	Y1000	QD1000	Kp----QD1004; Ki----QD1005; Kd----QD1006; Diff---QD1007; Death--QD1008
1CH	ID1001	ID1005	Y1001	QD1001	
2CH	ID1002	ID1006	Y1002	QD1002	
3CH	ID1003	ID1007	Y1003	QD1003	

#### Notes:

- (1) Kp: proportion, Ki: integral, Kd: differential, Diff: control range
- (2) Diff: to do PID control in appointed area.
- (3) PID control bit (Y): Y=0, PID control is unable; Y= 1, PID control is able.
- (4) Death: to compare the former and the current PID control value, if the difference is less than death area, the module will abandon the current PID control value and send the former value into the PLC.

### 4.5 Working mode

There are two method to set the working mode.

- Set through XCPpro software.
- Set through FD register.

- (1) Set through XCPpro software

Open XCPpro software, click Configure/BD setting. Then choose “BD-4AD-P-XC” in the setting window. And set the working mode of each channel. Then click OK to confirm. Then restart the PLC and download the user program to make the setting valid.

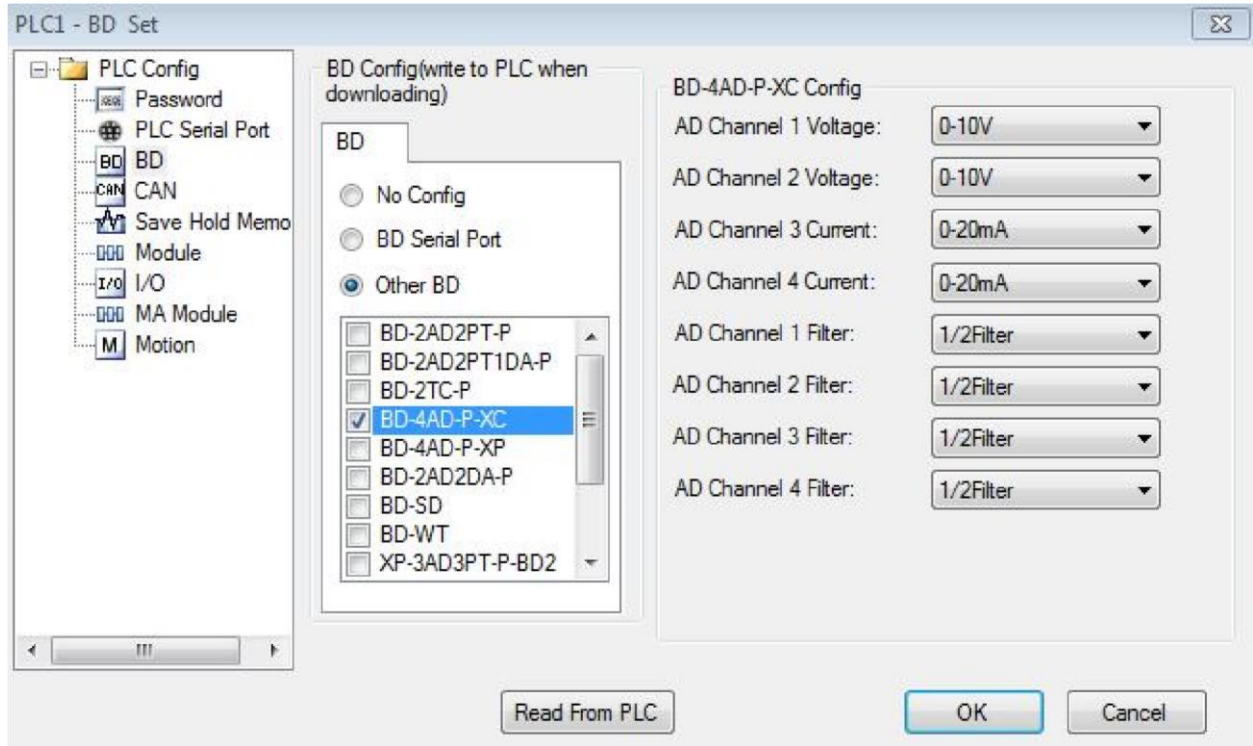

(2) Set through FD register

The expansion BD board has 0-5V and 0-10V voltage input choices; 0-20mA, 4-20mA current input choices. They can be set by FLASH register in the PLC. As the right diagram showing, each register can decide the modes of 4 channels. Every 4 bits of the register can decide one channel's mode.

One register has 16 bits, every 4 bits can decide one channel's working mode.

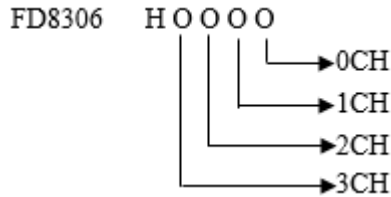

Register FD8306:

Channel 1				Channel 0			
Bit7	Bit6	Bit5	Bit4	Bit3	Bit2	Bit1	Bit0
00: 1/2 filter 01: no filter 10: 1/3 filter 11: 1/4 filter		0	0: 0~10V 1: 0~5V	00: 1/2 filter 01: no filter 10: 1/3 filter 11: 1/4 filter		0	0: 0~10V 1: 0~5V
Channel 3				Channel 2			
Bit15	Bit14	Bit13	Bit12	Bit11	Bit10	Bit9	Bit8
00: 1/2 filter 01: no filter 10: 1/3 filter 11: 1/4 filter		1	0: 0~20mA 1: 4~20mA	00: 1/2 filter 01: no filter 10: 1/3 filter 11: 1/4 filter		1	0: 0~20mA 1: 4~20mA

#### 4.6 The application of PID output

When the module is doing temperature PID regulation, it will output a PID control value every 2 seconds. So, in the PLC program, we could make heating control through the duty ratio of PID output value and K4095 in 2 seconds! Assume PID output value is X ( $0 \leq X \leq 4095$ ). It carries on duty ratio control in the cycle of 2 seconds, heater output for  $2X/4095$  seconds, heater close output for  $(2 - 2X/4095)$  seconds.

#### 4.7 Programming

Read the AD value of channel 0, set the PID parameters of channel 0, read the PID output value.

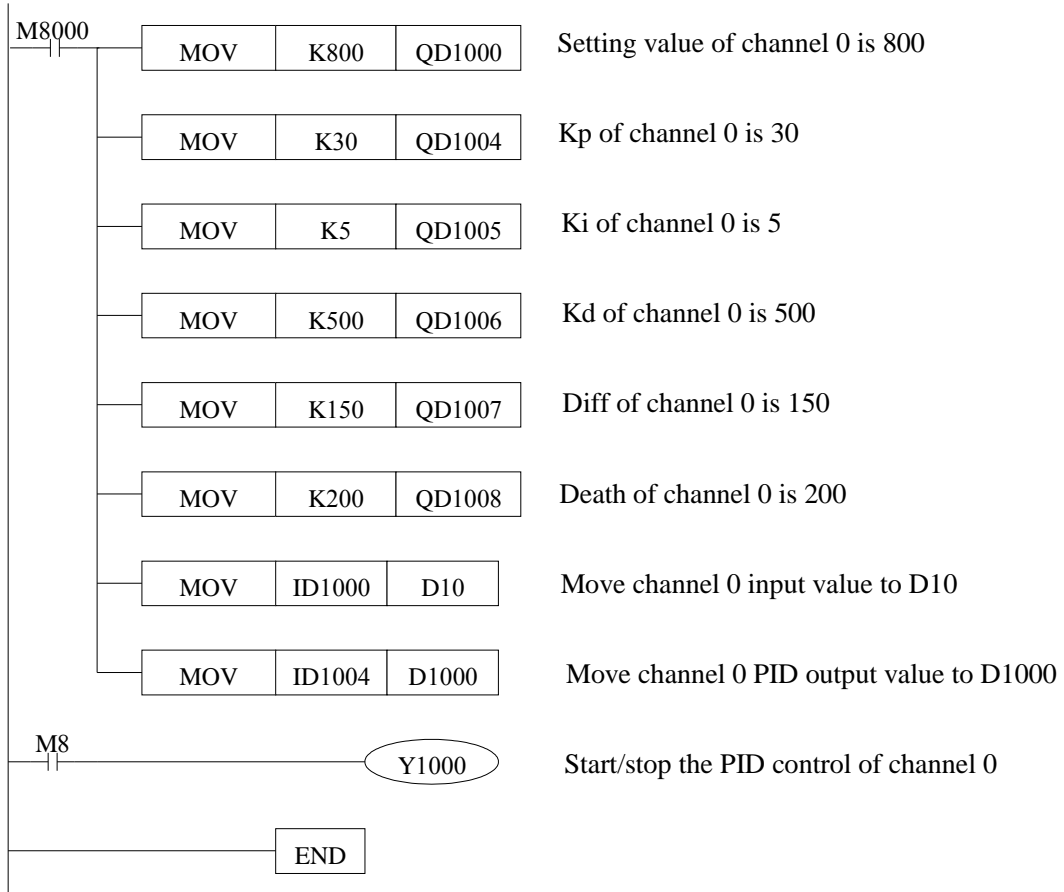

## 5. XC-COM(-H)-BD

### 5.1 Characteristic

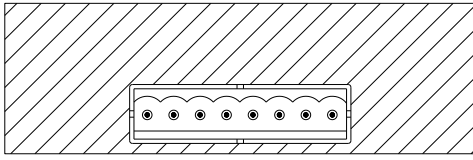

- RS485 communication port
- RS232 communication port
- RS485 and RS232 cannot be used at the same time
- XC-COM-H-BD has isolation for RS485

### 5.2 Wiring

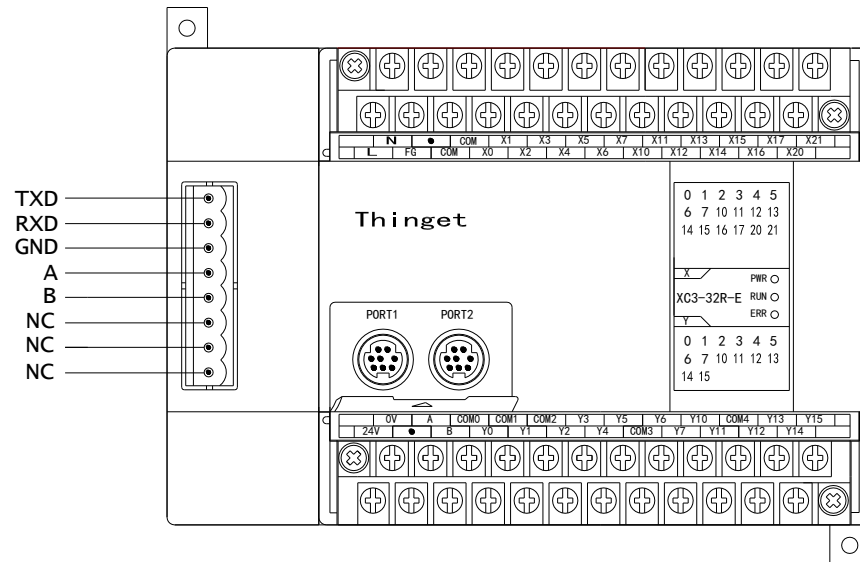

Notes:

- (1) TXD, RXD, GND are RS232 communication port.
- (2) A, B are RS485 communication port.
- (3) RS232 and RS485 cannot be used at the same time.

### 5.3 XC software setting

Open the XCPpro software, click configure/BD settings. Choose BD serial port in the BD set window and click ok. Then restart the PLC and download the program to make the setting valid.

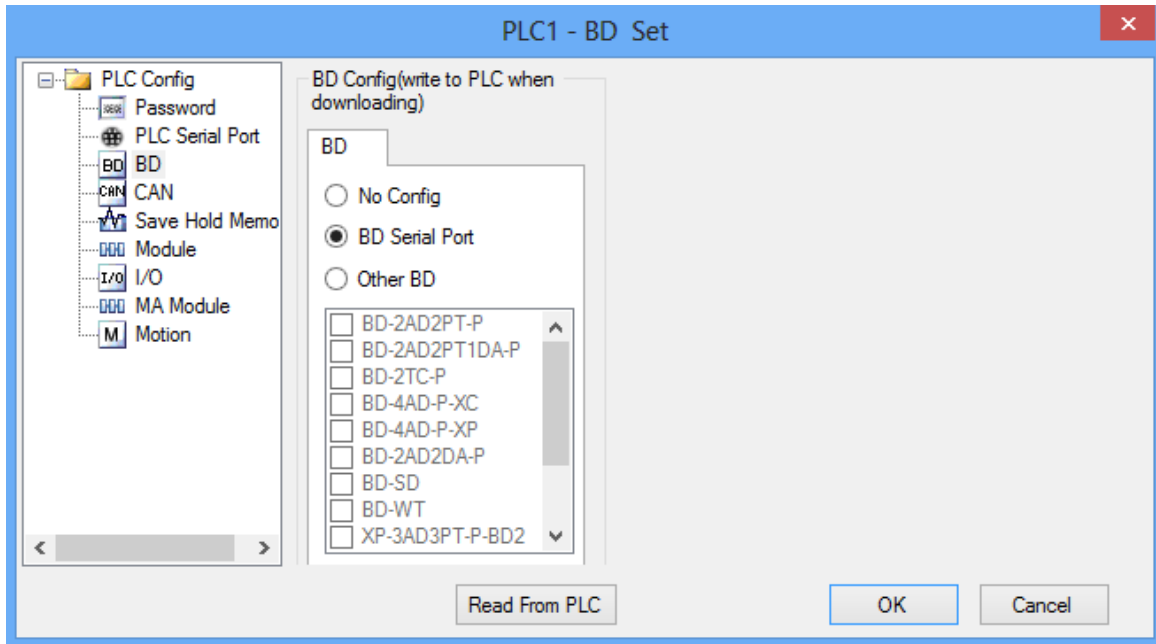



## 6. XC-SD-BD

### 6.1 Characteristic



- To install SD card and expand the XC memory
- PLC can read and write the data of SD card
- Support 4 data formats ( single word, double word, float, character )
- XC hardware version V3.2 and above is required

### 6.2 Explanation

#### (1) SD card

- XC-SD-BD has not been installed the SD card when out of factory, user needs to prepare MicroSD ( TF card ), the card memory should be not more than 2GB.
- Before install the SD card in the XC-SD-BD, please use card reader to format the SD to FAT16 in the PC.
- SD card supports hot plug, but please wait for at least 5 second after hot plug.

#### (2) The file standard in SD card

- SD card supports .csv file, these file should be saved in the root directory.
- All the .csv files must be named as dataxxx.csv, xxx is the file index number, the range is 001~999, when xxx is less than 100, add 0 from the left side. For example, if file index number is 1, the file name will be data001.csv.

#### (3) Data format and type in SD card

- SD card supports 4 kinds of data type: single word (W), double word (DW), float(Fm.n), character (Sx).
- The data range and space:

Data type	W	DW	Fm.n(m<=15,n<=15)	Sx(x<=16)
Data range	-32768~ 32767	-2147483648~ 2147483647	-18446742974197923840~ 18446742974197923840	\
Character occupied in SD card	6	11	m+1+n	2*x
WORD number	1	2	2	x

**NOTE:**

- (1) When the real data length is less than the character length in SD card, add space from the left side. For example, single word data 454, data type is W, character length is 6, so add 6-3 = 3 spaces. The real number is L L L 454. (L is space).
- (2) When Fm.n is negative number, the sign bit occupies one character. For example, F5.3, after writing the number -12345.123 in SD card, the lowest valid bit will be deleted; the number will become -12345.12.
- (3) The x of character Sx means word length, but not character length.

### 6.3 Operation for the SD

XC series PLC can connect SD card, write and read the data from the SD card.

#### (1) Read the SD card

After installing the SD card successfully, PLC can read the SD card data. Use FROM instruction to read the appointed data block in .csv file of SD card.

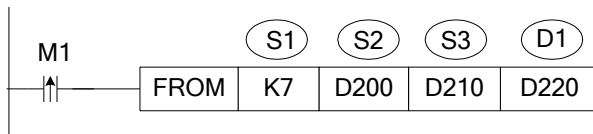

- Read the data from SD card to PLC, unit is word.
- S1: K7 means the object is XC-SD-BD.
- S2~S2+2: appoint .csv file index number, the column head address of data block, the row head address of data block. Operand is D.

In the example, D200 is the .csv file index number

D201 is the column head address of the data block

D202 is the row head address of the data block

- S3: the word numbers you want to read out. Operand is D.
- D1: save the data in PLC register. Operand is D.

In this example, if D200=2, D201=1, D202=3, D210=3. The instruction will do like this: read 3 numbers start from column 1, row 2 of the file “data002.csv” in SD card, and save it in D220 of PLC. If the data002.csv is shown as the following, then the numbers in the red color line will be read.

w,	dw,	s8,	f4.	15,	dw,	w,	dw
2980,	178605,	HFASDFNQWEJFN,	769.467894,	-1321240,	-330,	780240	
2471,	-191280,	JKSAHDKFHAKLS,	830.26683,	-2515275,	-23782,	-665320	
9628,	39984,	jakjfkakl,	387.56305,	458388,	-7728,	-884013	
9045,	-251190,	testh,	949.899791,	-417510,	39600,	195264	
1824,	141351,	hellbaby,	408.248854,	2644828,	-1836,	558904	
22300,	70153,	testh,	570.088499,	-583542,	-6534,	1095926	
-1742,	271975,	HSDKLJDF,	162.57849,	-1238233,	-25761,	-125260	
1636,	207536,	JSKDJFDSALF,	735.422261,	293940,	2400,	345495	
9962,	37107,	HDJNFCJDSNC,	860.864485,	538920,	24660,	827472	

#### Explanation:

- (1) In the data002.csv file, the first line is data type definition; this line is included in the row address.
- (2) The number “2471” is W type, “-191280” is DW type, so totally 3 words, the same as the read out word numbers.

## (2) Write SD card

By TO instruction, PLC can write the data into appointed location in .csv file of SD card. Please note that user must build a .csv file in the SD card at first, and define the write in data type in the .csv file. If not, the ERROR LED of XC-SD-BD will be always ON.

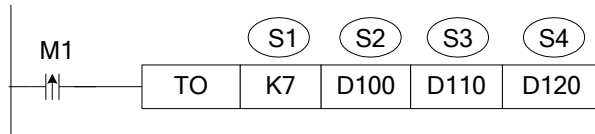

- Write the appointed data block of PLC in the SD card .csv file. Unit is word.
  - S1: K7 means the object is XC-SD-BD.
  - S2~S2+2: appoint the .csv file index number, the column and row address of data block. Operand is D.  
In the instruction, D100 is the index number of the .csv file  
D101 is the column address of the data block  
D102 is the row address of the data block
  - S3: the word numbers need to write in the SD card. Operand is D.
  - S4: the PLC register head address need to write into the SD card. Operand is D.
- In the instruction, if D100=1, D101=1, D102=2, D110=5, D120=365, D121=10235465, D123=26456. So the data will be written in data001.csv is in the red color range:

```
w, dw, dw, f4. 15,
365, 10235465, 26456, 769.467894,
2471, -191280, 70153, 830.26683,
```

**NOTE:** the write in data type should be the same as the .csv file data type. If not, the ID1000 will be error.

## (3) Notice

- Character type Sx
  - A. Sx supports visible character such as letter, number, the same as ASCII code [32,126], but not support comma “,”.
  - B. Invisible character, Sx supports end character.
- Reading and writing word quantity limitation
  - A. Limited by the RAM capacity of PLC, the reading and writing word quantity should be less than 50.
  - B. Cannot read part of the data. For example, define the data type to be “W, DW, S8”, if the reading word quantity is 10 and read from the first column W, the S8 will not be read completely, ID1000 will return error value. When the program found that the parameters were wrong, it will not read and write the SD card.
  - C. When reading or writing data, if one row is over, it will jump to the first column of the next row.
  - D. “.csv” file cannot have space between data. When writing data into SD card, the address must be continuous, if not the ID1000 will have error code 20.

E. When reading the data, the address cannot over the last data address, if not the ID1000 will produce error code.

- Default operation file

To save the time, after installing the SD card, it will read the data001.csv file, if there is no this file in the SD card, ID1000 will return code 2. But this will not affect the following operation for data001.csv file.

#### 6.4 SD card state information ID1000

The SD card state information will show in ID1000. Especially when SD card has error, it can check the error code in ID1000 to find the solution.

ID1000	Meaning	Reasons
0	Successful	
1	Initialization failure	SD card is not installed well or is damaged
2	Reading or writing file does not exist	The operation file does not exist
3	Reserved	
4	Reserved	
5	Reserved	
6	Reserved	
7	Reserved	
8	Reading or writing error	Uninstall the SD card when reading or writing
9	Reserved	
10	Reserved	
11	FAT16 error	SD card has not been formatted to FAT16
12	Reserved	
13	Reserved	
14	Reserved	
15	Reserved	
16	Reserved	
17	Reserved	
18	Reserved	
19	SD card is not inserted	SD card is not inserted
20	Reading or writing parameter error	Please check the file index number, column, row and word number

21	The reading or writing data are not fit for format definition	There are illegal characters when data type is character
22	The file data type is wrong	There are data type definition exclusive of “w, dw, Sx, Fm.n”
23	Data type is not matching when reading the file	There are illegal characters when data type is character
24	Illegal file name	Index number >999
25	Illegal column index	Column index > file column numbers
26	Illegal row index	Row index number is 0 or 1
27	Illegal reading and writing word numbers	Word numbers >50

### 6.5 The type definition in “.csv” file

Before writing data into .csv file, you need to define the data type in the Excel table.

A. Build a new Excel file, define the data type in the first row.

	A	B	C	D	E
1	w	dw	f3.2	s5	dw
2					
3					

B. Save the file and named as dataxxx.csv. For example, data003.csv.

C. After saving the file, open it in txt file, you will see the following things: each data type is divided by “,” automatically. In that way PLC can recognize it easily.

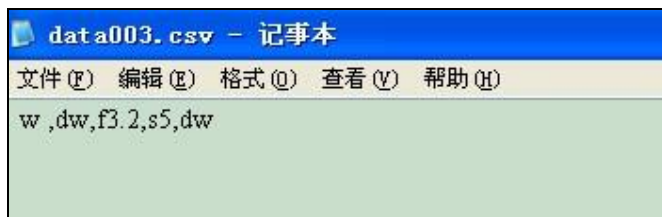

### 6.6 Install and set the BD board

#### (1) Install the BD board

Open the PLC cover on the right, insert the BD board with the pins then fix it with screw, then put the cover back.

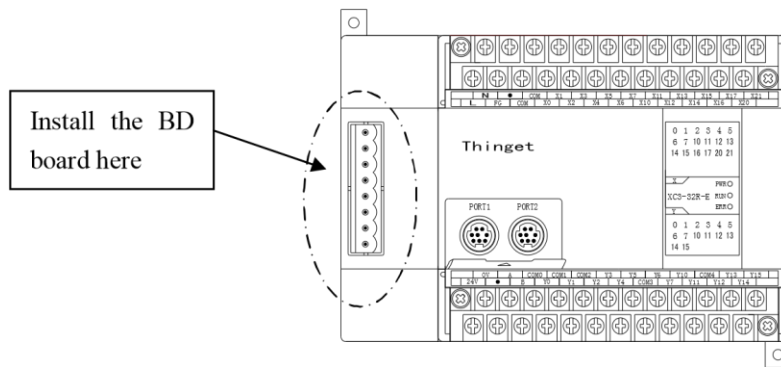

## (2) Install SD card

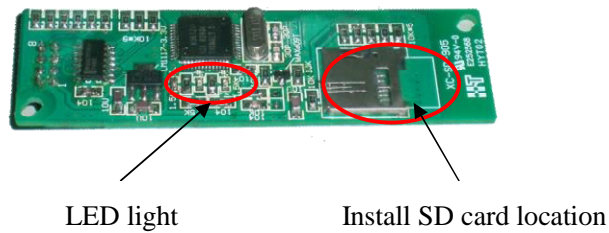

There are three LED lights on the XC-SD-BD, they are Power, Run and Error.

Power: always ON after power on;

Run: blinking when PLC and BD communication is normal

Always ON when PLC and BD communication is abnormal

Error: Off when there is no error

Always ON when there is no SD card, SD card broken or SD card is not formatted.

Blinking when there are other errors.

## (3) Configure the BD board

Open XCPpro software, click “configure/BD setting, then select other BD/BD SD, then click OK. Then restart the PLC and download program to make the setting valid.

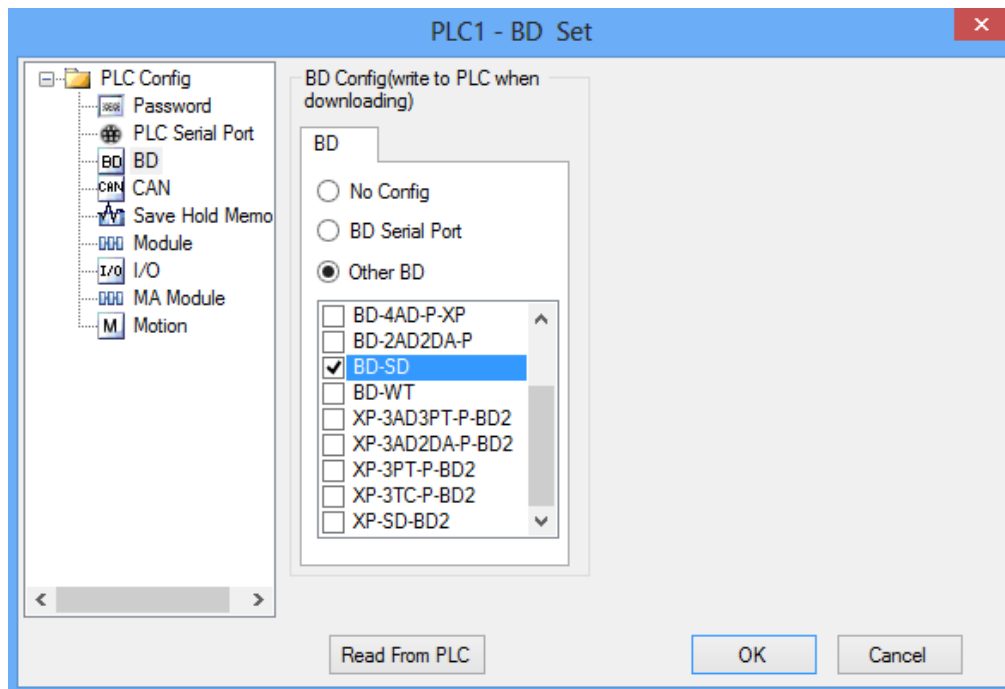

## 6.7 Format changing tool

When there are data in the Excel, please use format changing tool to transform the Excel format to .csv. The tool will be attached with this manual. Please see the operation steps:

- (1) Open Excel, click Tool/Add-Ins/Browse..., then select the format changing tool, click ok.

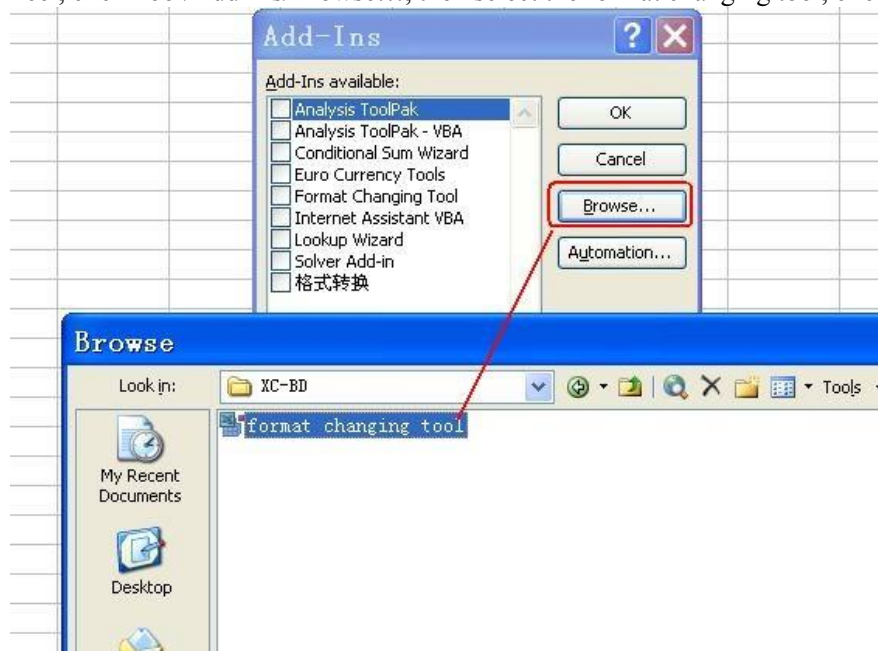



(2) In the tool menu, there is a format changing tool item. That means the tool installation is finished. When finished the data inputting, click “format changing tool”.

At last, save the file as .csv format.

	A	B	C	D	E	F	G	H
1	w	dw	s8	f4.15	dw	w	dw	
2	2980	1786	HFASDF		-13212	-330	780240	
3	2471	-1912	JKSAHL		-25152	-23782	-665320	
4	9628	399	jak		4589	-7728	-884013	
5	9045	-2511			-4175	39600	195264	
6	1824	1413	f		26448	-1836	558904	
7	22300	701			-5839	-6534	1095926	
8	-1742	2719	f		-12382	-25761	-125260	
9	1636	2079	JSKI		2939	2400	345495	
10	9962	371	HDJM		5389	24660	827472	

## 6.8 Example

Write data in data001.csv in SD card, read data from data002.csv.

Process: format the SD card → build a csv file → make the program → install SD card and BD board → configure the BD board, download the program and the data → debug the program, monitor the running result Step:

1. Transform the SD card format to FAT16 by card reader

- (1) Use card reader to connect SD card with PC. (SD card capacity should be less than 2GB).
- (2) Right click the SD card disk, choose format.
- (3) File system please select FAT.
- (4) Click start to format the SD card.

2. Build an empty file “data001.csv” and a file “data002.csv” with data in the root directory of SD card.

- (1) Open the SD card, build two new Excel files.



(2) Open one of the file, input the following data types:

1	w	dw	f5.3	s7	w
2					

(3) Save the file as "data001.csv". Then open it in txt, make sure it is correct.



(4) Open another Excel file, input the data type in the first line, and input data in each row, the data in each row should be accord with the data type.

	A	B	C	D
1	w	s8	dw	f6.2
2	245	hfiw	1234567890	543631.32
3	415	sdlgjeoa	-534007321	464.1
4	14456	8gskhd	77182	7654.65
5	26654	nd903jlp	8945	3563
6	12356	48djlj=j	9054873	-13251.98
7	97	ey67	326483894	-645.8
8	-27658	e21	89490	15.54
9	4579	k*nlw	737328923	3165.3
10				

(5) Transform the data via format changing tool.

	A	B	C	D
1	w	s8	dw	f6.2
2	245	hfiw	1234567890	543631.32
3	415	sdlgjeoa	-534007321	464.1
4	14456	8gskhd	77182	7654.65
5	26654	nd903jlp	8945	3563
6	12356	48djlj=j	9054873	-13251.98
7	97	ey67	326483894	-645.8
8	-27658	e21	89490	15.54
9	4579	k*nlw	737328923	3165.3

(6) Save as "data002.csv". Then open it in txt file:

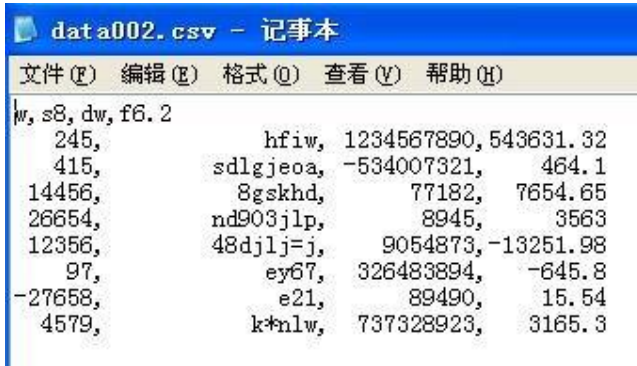

Before



After

**Attention:** after format changing, if the data length is not enough, it will add space from the left side of the numbers. Before format changing, the data are out of order.

(7) File “data001” and “data002” setting are finished. Please delete the disk and pull out the SD card from the PC.

### 3. Make program in XCPpro software.

(1) Purpose:

A. write 16 words from D200 to row 1, line 2 of data001.csv.

B. read 25 words from row 2, line 3 of data002.csv to D400.

(2) Process:

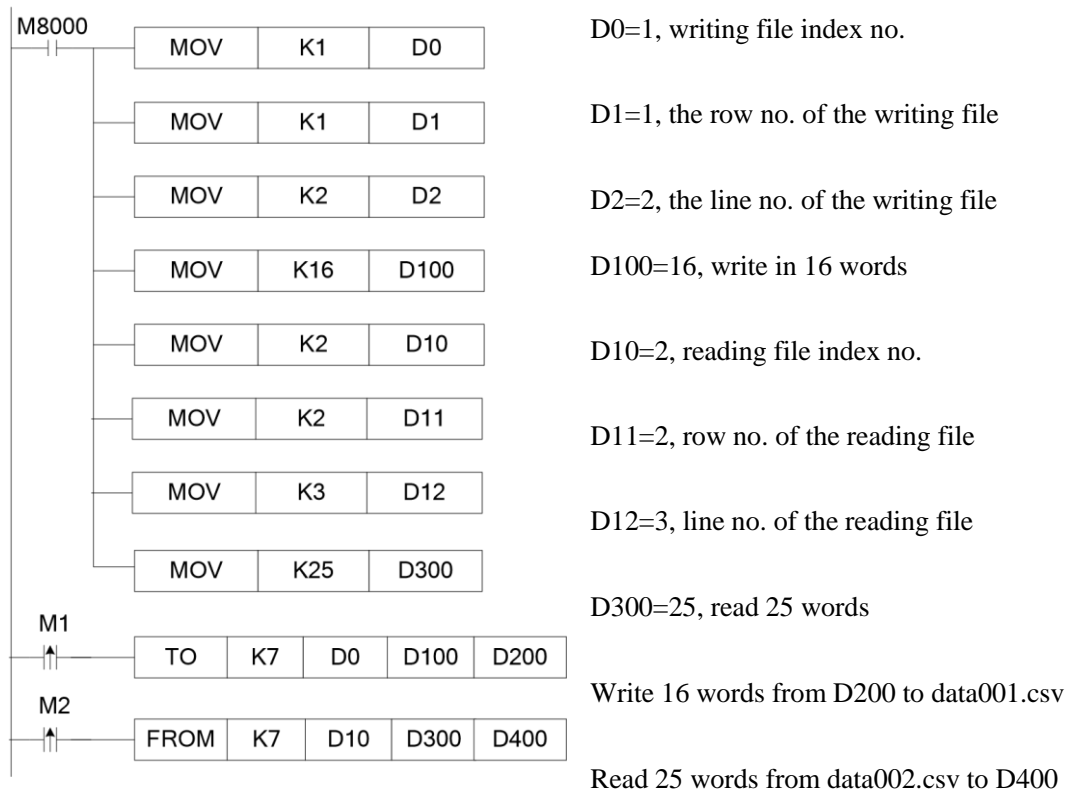

4. Insert the SD card on the XC-SD-BD, install the BD on the PLC.

(1) Power on the PLC, check the LED situation. POWER LED is ON, communication LED is flickering, ERROR LED is OFF.

(2) Connect the PLC with PC to configure the BD board.

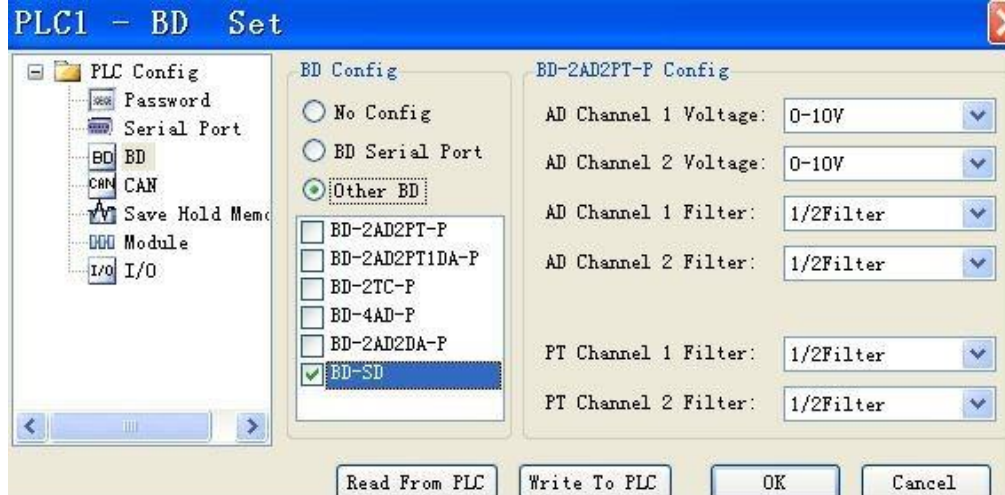

(3) Click "Online--- download program & data" select "BD config" in the window:

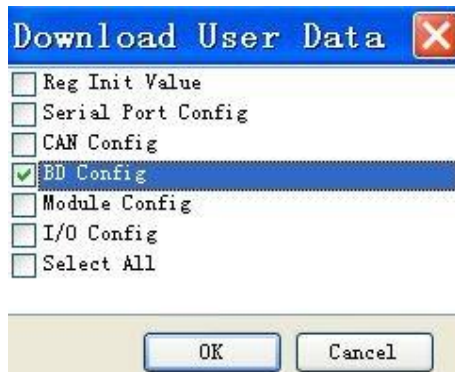

(4) Click the BD details in the project; you can see the BD board information.



5. Run the program to see the result.

A. Write data into data001.csv

a) The data in D200~D215 of PLC are shown as the following:

Reg	Monitor value	Word length	Num Format
D200	12335	Word	Dec
D201	555881125	DWord	Dec
D203	78545.23	Float	Dec
D205	gh	Word	ASCII
D206	45	Word	ASCII
D207	9j	Word	ASCII
D208	3#	Word	ASCII
D209	+<	Word	ASCII
D210	5v	Word	ASCII
D211	?&	Word	ASCII
D212	-6786	Word	Dec
D213	-23412	Word	Dec
D214	-474327809	DWord	Dec

b) When M1 is from OFF→ON, write the data from D200~D215 to data001.csv.

The result of data001.csv is as the following:

```
w, dw, f5. 3, s7, w
12335, 555881125, 78545. 227, gh459j3#+<5v?&, -6786
-23412, -474327809,
```

B. Read data002.csv

a) The data will be read in data002.csv:

```
w, s8, dw, f6. 2
245, hfiw, 1234567890, 543631. 32
415, sdlgieoa, -534007321, 464. 1
14456, 8gskhd, 77182, 7654. 65
26654, nd903jlp, 8945, 3563
12356, 48djlj=j, 9054873, -13251. 98
97, ey67, 326483894, -645. 8
-27658, e21, 89490, 15. 54
4579, k*nlw, 737328923, 3165. 3
```

b) when M2 is from OFF→ON, read the data from data002.csv to D400~D424 of PLC:

D400		Word	ASCII
D401		Word	ASCII
D402		Word	ASCII
D403		Word	ASCII
D404	sd	Word	ASCII
D405	lg	Word	ASCII
D406	je	Word	ASCII
D407	oa	Word	ASCII
D408	-534007321	DWord	Dec
D410	464.1	Float	Dec
D412	14456	Word	Dec
D413		Word	ASCII
D414		Word	ASCII
D415		Word	ASCII
D416		Word	ASCII
D417		Word	ASCII
D418	8g	Word	ASCII
D419	sk	Word	ASCII
D420	hd	Word	ASCII
D421	77182	DWord	Dec
D423	7654.65	Float	Dec

C. the process of reading the data from SD card to PLC registers:

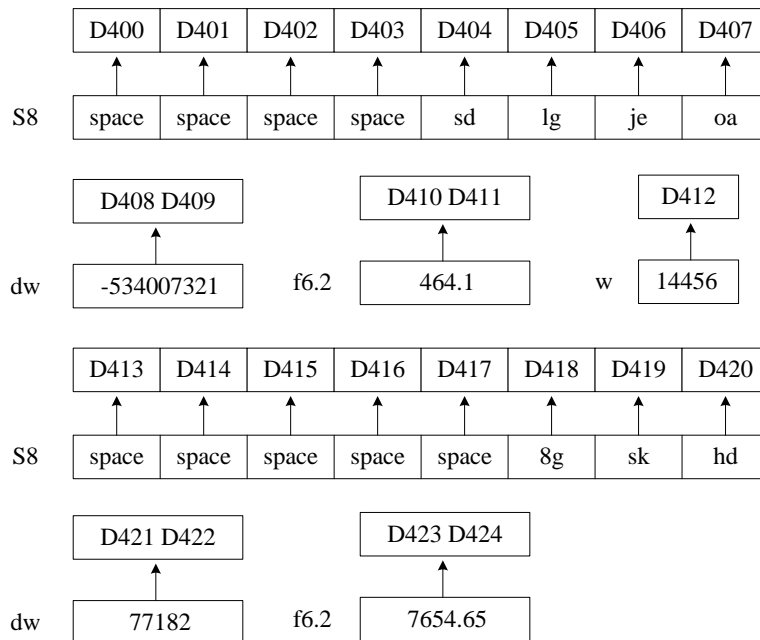

## 7. XC-TBOX-BD

### 7.1 Summarization



- Ethernet BD board is used to access to Ethernet, special for XC series PLC
- Support Modbus-RTU protocol
- Applied to remote monitor, program upload/download/modification
- XCPpro software version requirements:  
XC-TBOX-BD hardware v2.10, XCPpro v3.3  
XC-TBOX-BD hardware v2.0, XCPpro v3.0f

### 7.2 Characteristics

- Flexible distributed automation structure, simplify the system management
- Standard RJ45 interface, TCP/IP protocol
- To realize remote monitoring, checking and programming, save time and cost
- To store and deal with the data via Ethernet, simplify the data processing and filing
- Connect PLC with Ethernet to realize intercommunication with other devices
- High cost performance, easy to maintain, support simple user's friendly diagnose function

### 7.3 System construction

The industrial Ethernet system contains XC-TBOX-BD, PC, XC series PLC, XCPpro software, HMI, switch, twisted-pair cable, etc.

### 7.4 Suitable field

Industrial Ethernet is an electrical network which based on shielded coaxial cable, twisted-pair cable or optical fiber which based on optical network. It is accord with IEEE802.3 by using ISO and TCP/IP protocol. As the expansion of Modbus/RTU protocol, Modbus/TCP protocol defines the standard of TCP/IP network transmission and application. XC-TBOX-BD meets the requirements for industrial network automation control.

It provides complete solution and reliable control method.

The application based on XC-TBOX-BD:

- Remote monitor, maintain and debug the PLC program of the IP device
- Traditional Modbus communication is one-master-multi-slaver mode, the speed is very slow.  
By using XC-TBOX-BD, master station can communicate with other branch stations.

In the following picture, XC-TBOX-BD and TBOX support devices with Modbus/RTU interface connecting to Ethernet. It can realize multi-master-multi-slaver system; make the devices suitable for complicated system.

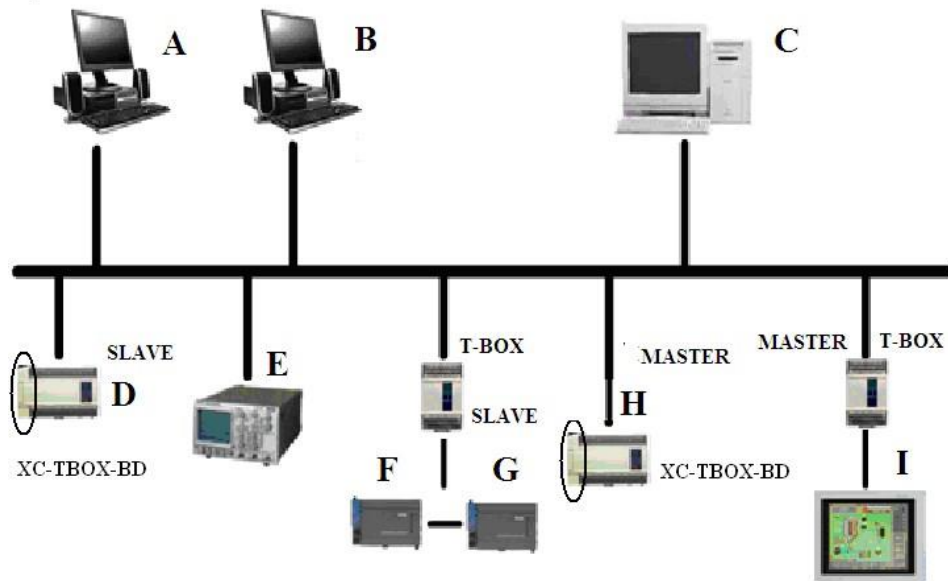

### 7.5 Interface for Ethernet

- Ethernet interface is RJ45

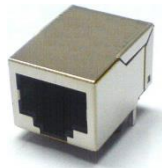

- The pin definition of RJ45:

Pin	Wire color	Signal	Direction
S1	Orange white	TXD+	Output
S2	Orange	TXD-	Output
S3	Green white	RXD+	Input
S4	Blue	-	-
S5	Blue white	-	-
S6	Green	RXD-	Input
S7	Brown white	-	-
S8	Brown	-	-

## 7.6 Configure the BD board

Install the BD board on the PLC

Connect PLC with PC, use XCPpro software to configure the BD board

Select configure/BD setting, then click BD serial port:

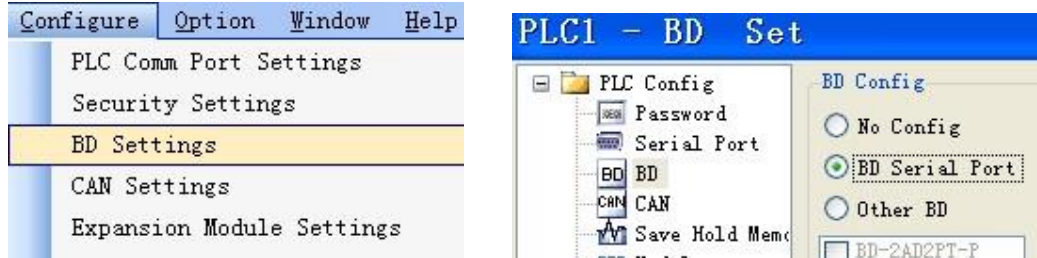

## 7.7 DIP switch

XC-TBOX-BD has four DIP switches:

ON

1	2	3	4
---	---	---	---

OFF

The function of DIP switch:

Switch	Status	Function
S1	ON	SLAVE mode
	OFF	MASTER mode
S2	ON	Shut down the server log-on
	OFF	Turn on the server log-on
S3	ON	Use user-defined IP address
	OFF	Use default IP address (192.168.0.111 )
S4	ON	-
	OFF	-

There are 2 modes to set the IP address: please select the mode via DIP switch

- A. Use default IP address
- B. Use user-defined IP address

The priority of the 3 modes are A>B.

**A: use default IP address (S3 OFF)**

When using the TBOX-BD at the first time, please use default IP address.

IP address: 192.168.0.111

Subnet mask: 255.255.255.0

Default gateway: 192.168.0.1



Preferred DNS: 192.168.0.1

**B : use the address set by users ( S3 ON)**

IP address, subnet mask, default gateway, preferred DNS (the same as default gateway)

### 7.8 LED display

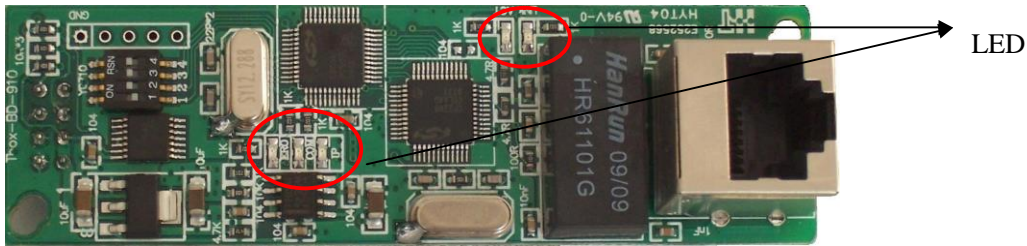

LED	Name	Function
REMOTE	Remote login	Always ON: log on the remote server
COM	Serial port	Shining: connected
IP	IP address	ON: IP address is conflicted
LINK	Ethernet link	Always ON: network connection is normal
ACT	Data receiving	Shining: receiving the data

### 7.9 Using steps

If you want to connect the PLC in the Ethernet, you have to set the T-BOX-BD first. Please see the steps:

#### (1) Hardware connection and setting

- A Install the XC-TBOX-BD on the PLC.
- B Confirm the XCPpro version.
- C Set the DIP switch according to the requirements.
- D Make sure XC-TBOX-BD is connected with Ethernet. Electrify the PLC.

Note: when using XC-TBOX-BD at the first time, please set DIP switch S3 to OFF, make it as static IP (192.168.0.111), then connect with Ethernet to set parameters. The IP of PC must in the same gateway of the TBOX-BD which is 192.168.0.xxx. As XC-TBOX-BD has the same default IP when out of the factory, only one can be configured in the network at the same time.

Initial configuration parameter list		
	TBOX	PC
IP address	192.168.0.111	192.168.0.***
Subnet mask	255.255.255.0	255.255.255.0
Default gateway	192.168.0.1	192.168.0.1
DNS server	192.168.0.1	192.168.0.1

E Make sure PC with XCPpro software are in the network.

## (2) Set the parameters

A. Open XCPpro software, click option/Ethernet module setting.

B. Click “refresh list” to find the existed XC-TBOX-BD in the network.

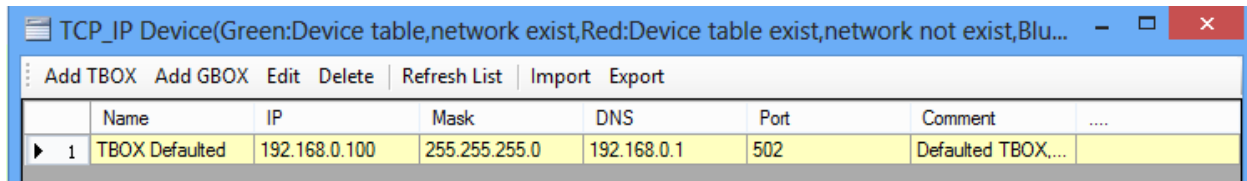

The screenshot shows a window titled "TCP\_IP Device(Green:Device table,network exist,Red:Device table exist,network not exist,Blu...". Below the title bar is a menu bar with options: Add TBOX, Add GBOX, Edit, Delete, Refresh List, Import, Export. Below the menu bar is a table with the following data:

	Name	IP	Mask	DNS	Port	Comment	....
▶ 1	TBOX Defaulted	192.168.0.100	255.255.255.0	192.168.0.1	502	Defaulted TBOX,...	

C. Double click the TBOX device, the “edit TBOX device” window will pop up.

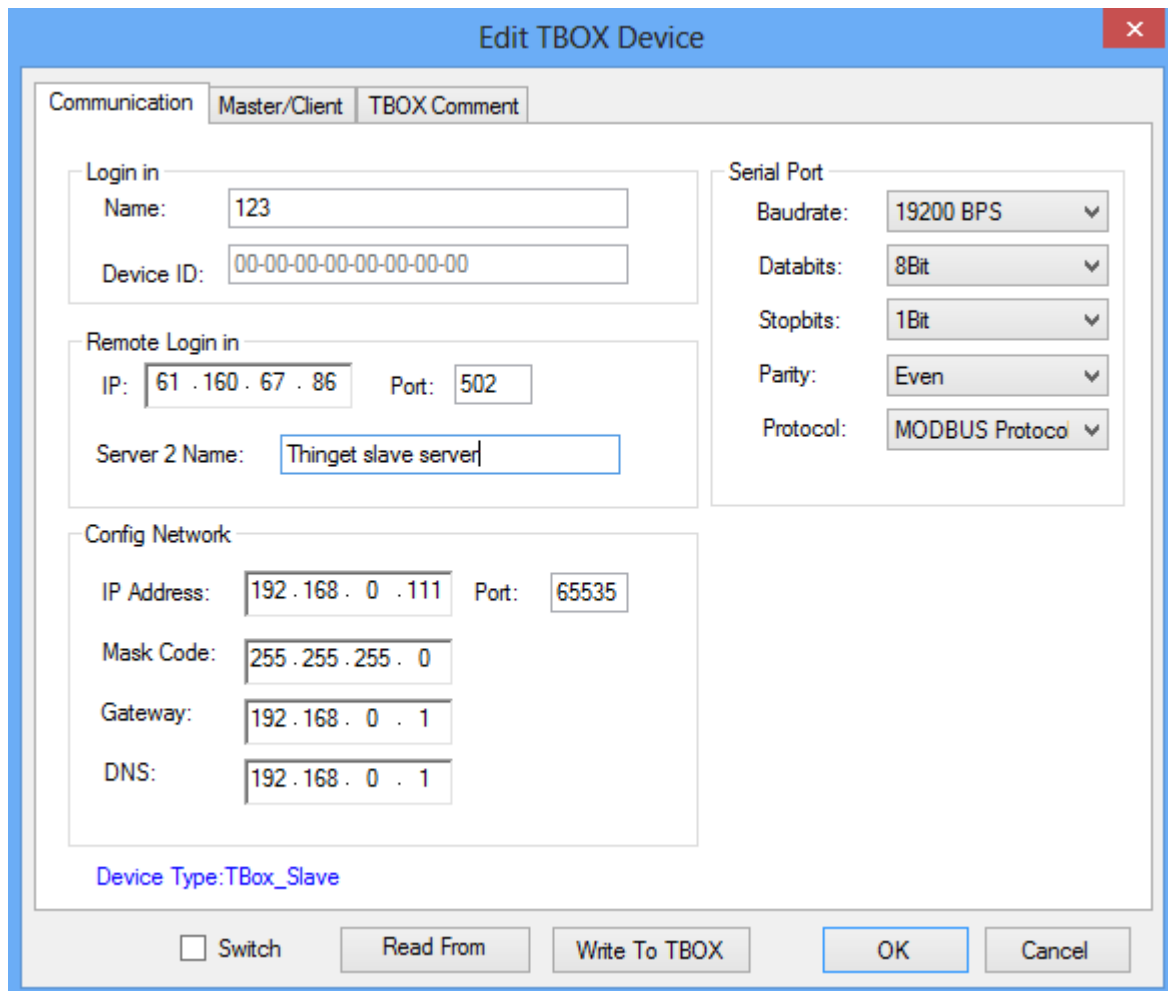

The screenshot shows the "Edit TBOX Device" window with the following configuration parameters:

- Communication:** Master/Client, TBOX Comment
- Login in:** Name: 123, Device ID: 00-00-00-00-00-00-00-00
- Remote Login in:** IP: 61.160.67.86, Port: 502, Server 2 Name: Thinget slave server
- Serial Port:** Baudrate: 19200 BPS, Databits: 8Bit, Stopbits: 1Bit, Parity: Even, Protocol: MODBUS Protocol
- Config Network:** IP Address: 192.168.0.111, Port: 65535, Mask Code: 255.255.255.0, Gateway: 192.168.0.1, DNS: 192.168.0.1

Device Type: TBox\_Slave

Buttons:  Switch, Read From, Write To TBOX, OK, Cancel

Explanation for the parameters:

- **Login in**

Name: define by user

---

Device ID: set by factory, cannot change

- **Remote login in**

The aim of setting this part of parameters is to connect the XC-TBOX-BD and its device into the WAN, user can maintain the remote devices via the remote login in function.

IP, port, server 2 name: if using XINJE server, it no needs to change the parameter; if customer has server, please set the IP, port and server name.

- **Config network**

When the DIP switch S3 is OFF, user can set the IP address, mask code, gateway, DNS(same to the default gateway) as the actual requirements. Please turn ON S3 after setting.

- **Serial port**

Baud rate, data bits, stop bits, parity, protocol. These parameters should be the same to connected device.

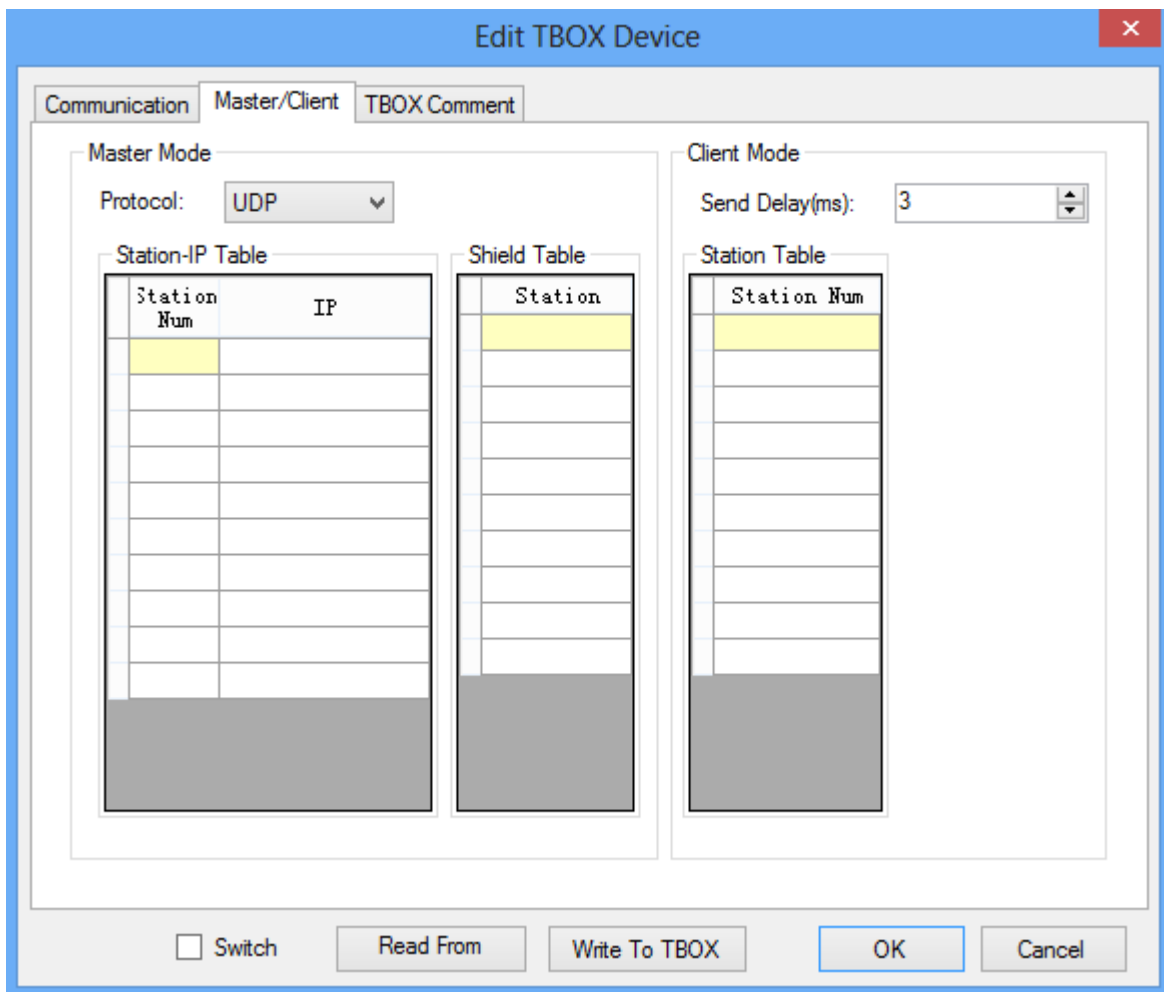

- **Master mode and client mode**

Under the “edit IP device” dialog box, it will show device type. When XC-TBOX-BD is master mode, it shows “device type: T-BOX\_Master”, the parameters setting of “Master” part is effective, “Slave” part is ineffective. When XC-TBOX-BD is slave mode, it shows “device type: T-BOX\_Slave”, the parameters setting of “Slave” part is effective and that of “Master” part is ineffective.

◆ **Device type: XC-TBOX-BD Master**

It includes two sections: protocol, station number- IP table.

- Protocol: UDP: more efficient and faster  
TCP: better stability to send and receive data, but occupy more resources
- Station number-IP table: station number: in Industrial Ethernet, the station number of Slave station  
IP address: slave station IP address

◆ **Device type: XC-TBOX-BD Slave**

It includes two sections: send delay (ms), static station number table.

- Send delay: as soon as XC-TBOX-BD receives the reply from Slave device, it will send next order at once. Adding delay time between reply and sending order to reduce the possibility of lose command packets of the slave device.
- Static station number table: the station number of Slave device in Industrial Ethernet, supporting direct access

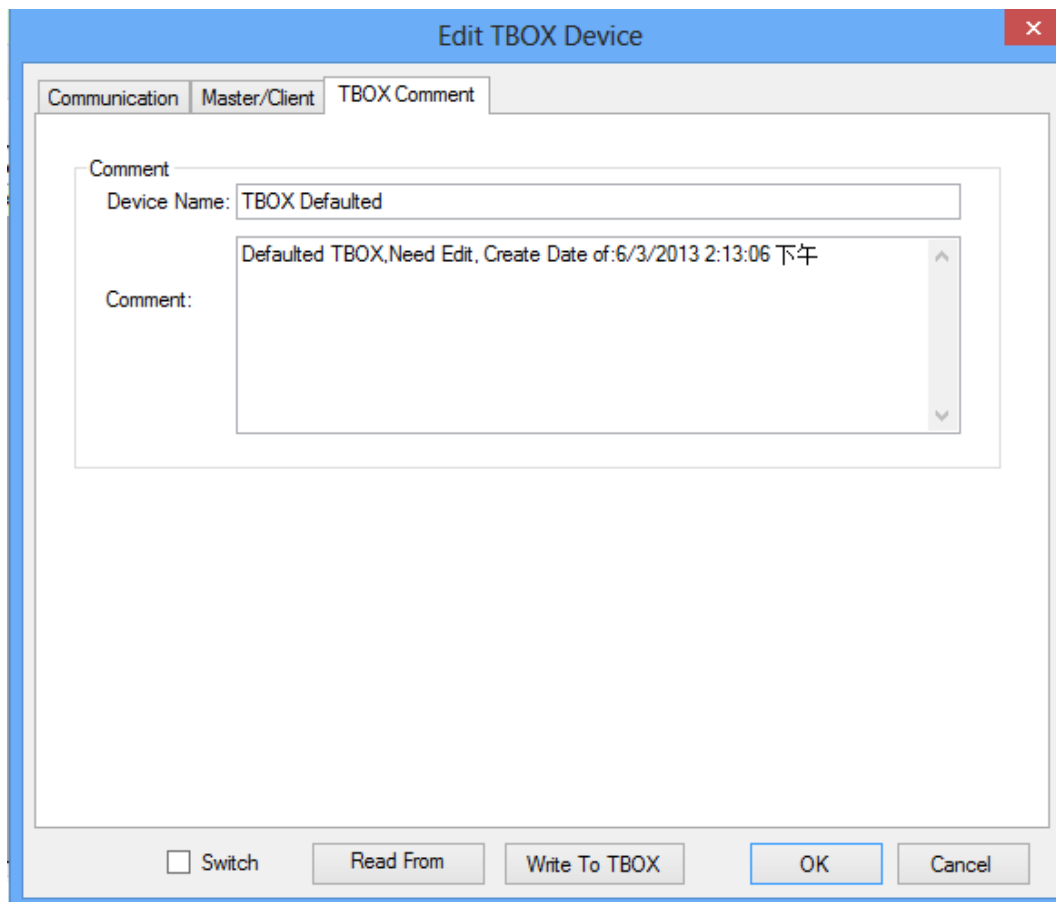

- **Comment**

It contains device name and comment. User can modify them and click OK to confirm.

- D. Click “Write to T-BOX”, then click “OK”. The devices will be listed in the TCP-IP device window. Close this window.
- E. It shows “select communication mode” window. Please choose UDP for communication mode. The network type can be inner or outer network.

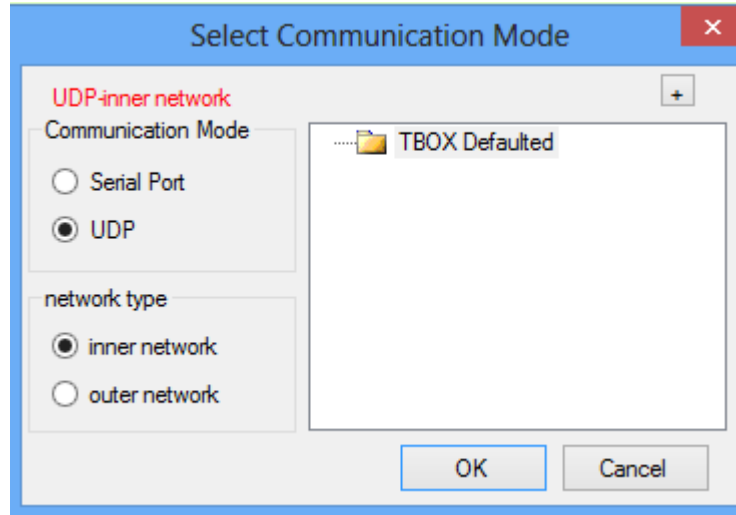

G Click “OK” to finish the XC-TBOX-BD parameters setting.

## 7.10 Connect to SCADA

When use WAN, XC-TBOX-BD can connect with Touchwin SCADA (version 2.c.5 and higher).

The steps are as below:

- (1) Open Touchwin software, build a new file

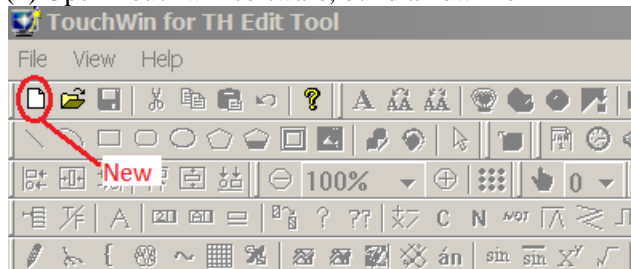

- (2) Select PC HMI software/Win800\*600 or Win 1024\*768 (according to your PC screen size).

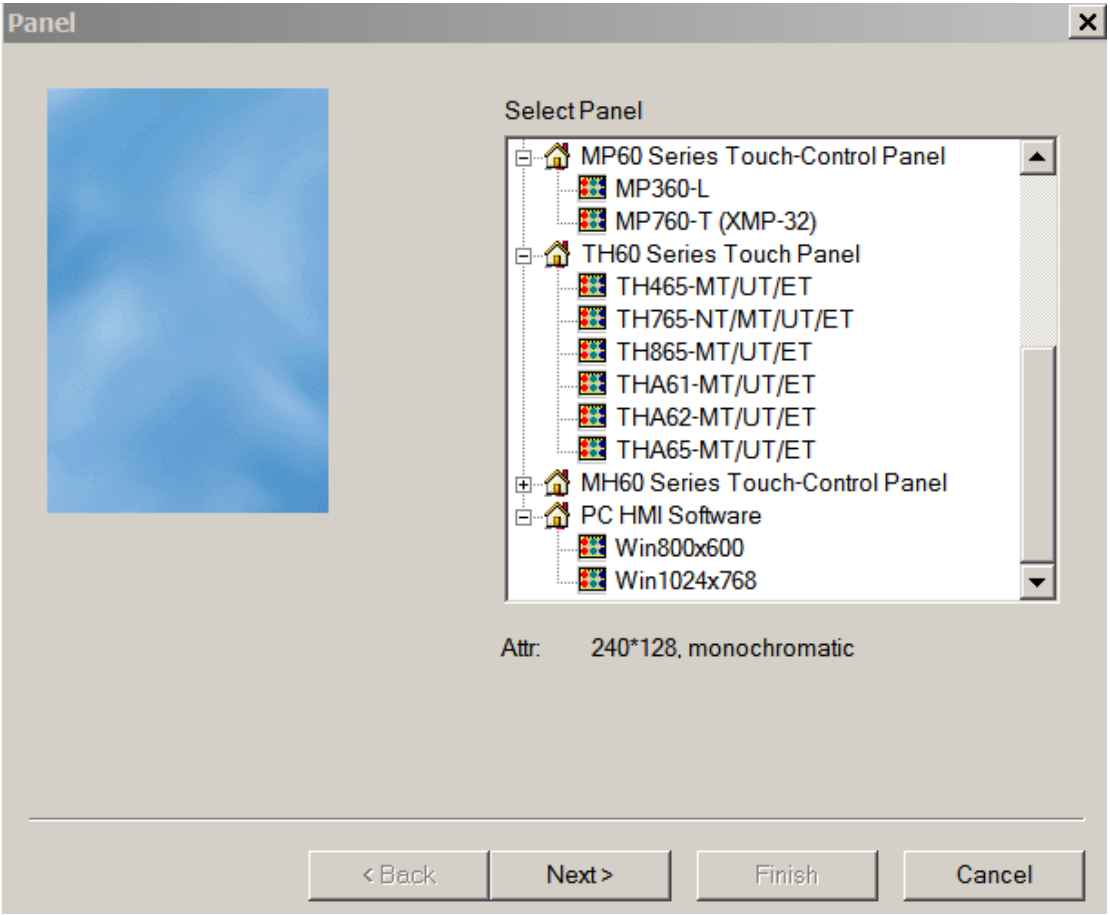

(3) Click "Next", then PLC port device select "Thinget XC series"

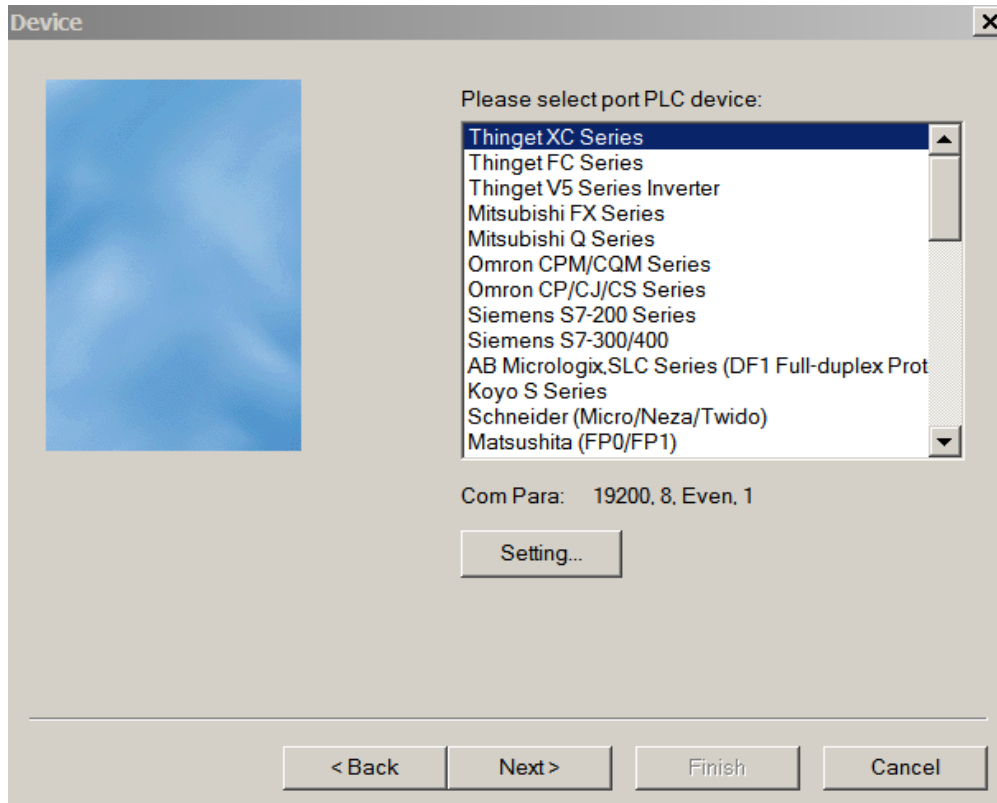

(4) Download port device select “unused download port” then click “Next”

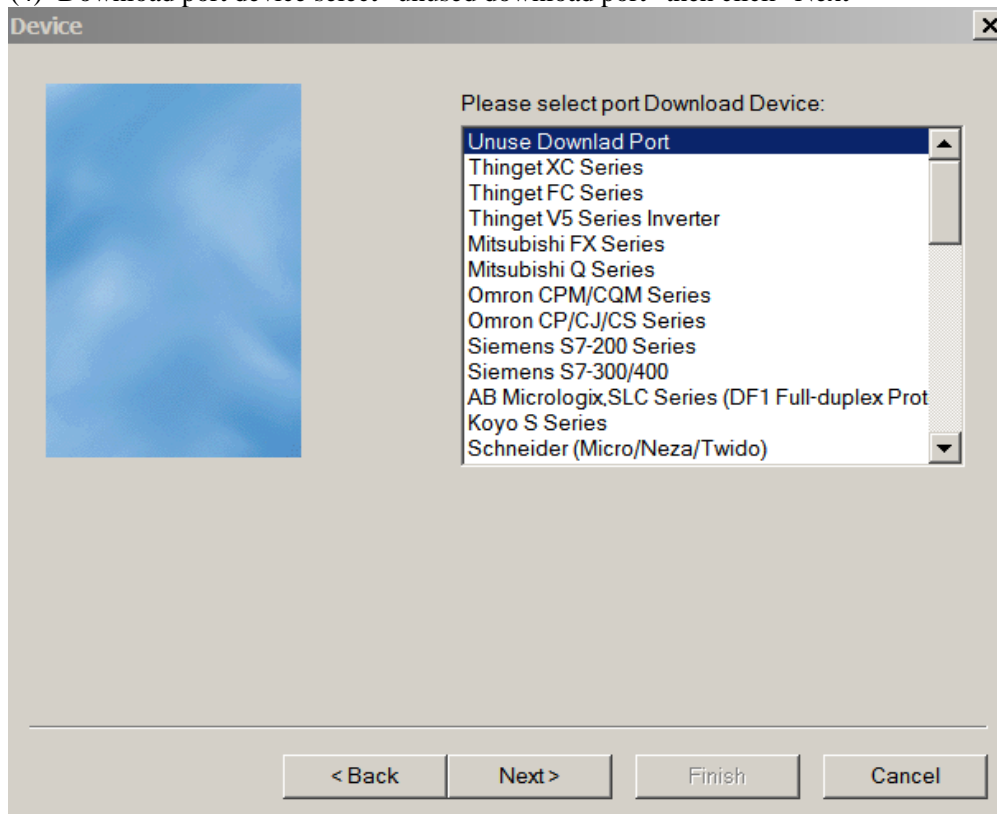

(5) The parameters in below window:

- Name: TBOX log in name
  - User ID: TBOX log in device ID. Please delete the “-“ when input the ID. For example: ID 01-10-02-21-00-01-00-00 will be 0110012100010000.
  - Device: select the device in the drop-down list, then click “Add”.
  - Server IP and port: XC-TBOX-BD remote log in IP and port.
- Click “Next” to finish the configuration.

Net Device

Name

User ID

Device

thinget ThingetXC Series

Server IP  Port

(6) Make the project in below window:



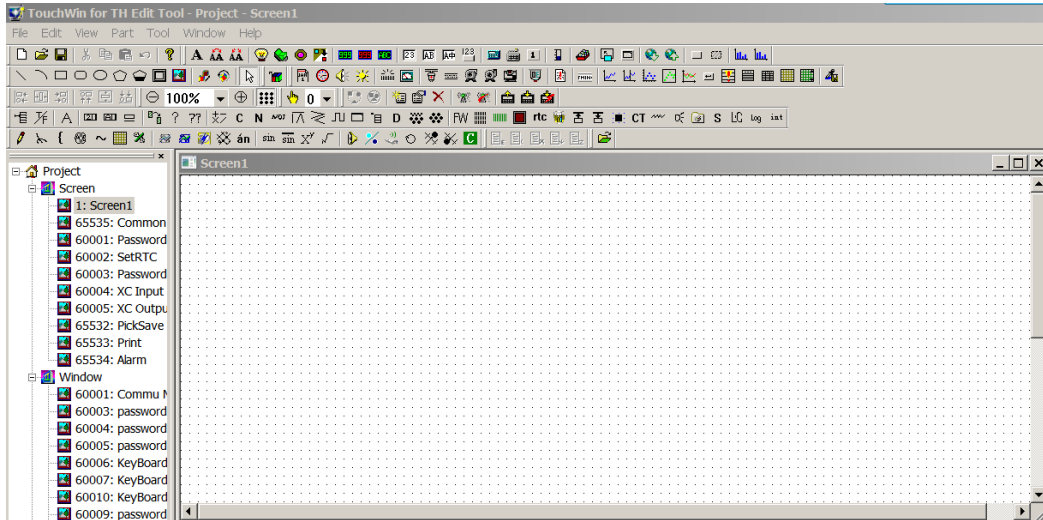

Please note: for all the objects in the project, please change the “PLC port” to network device. For example: the lamp button, change “PLC port” to “thinget XC series”.

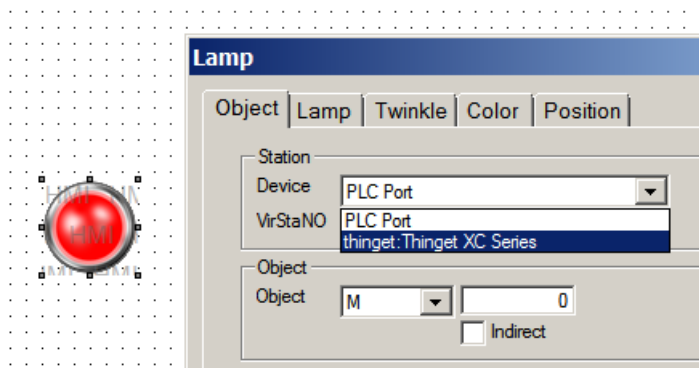

(7) After finishing the editing of project, click online simulation button to monitor the remote device.

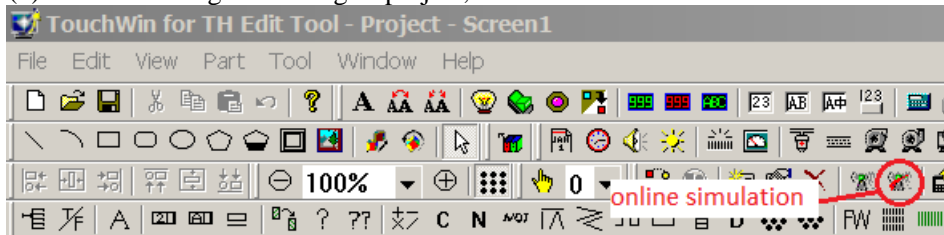

## 7.11 Application

The following is an Ethernet consisted of three PLC and one HMI.

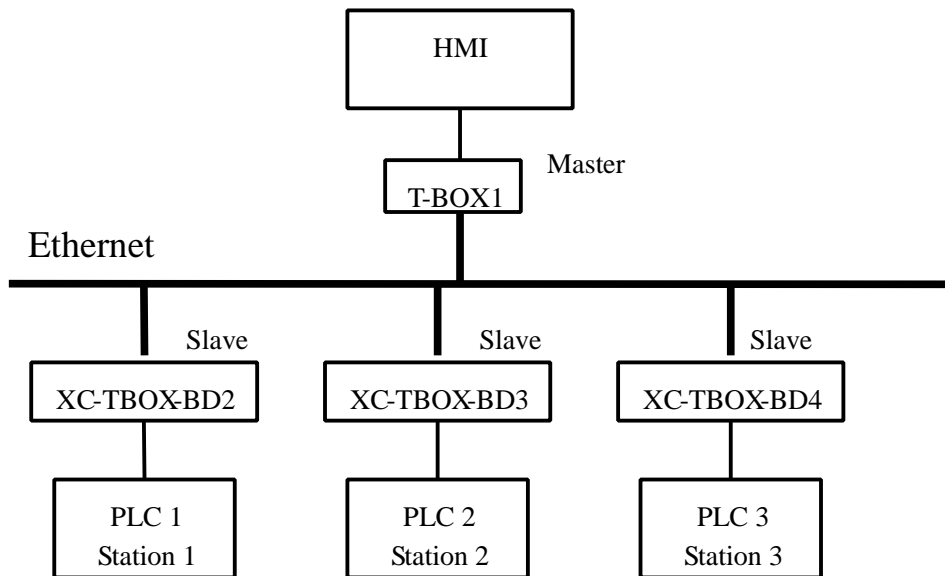

In this system, there are 3 XC-TBOX-BD and 1 T-BOX. T-BOX is master mode, others are slave mode. HMI is master device, PLC1, PLC2, PLC3 are slave devices.

This system's purpose is to control many slave devices by one master device. Make the industrial network being used widely.

The steps are as shown as below:

- (1) Confirm the station number of the 3 PLC via XCPpro software.
- (2) Connect TBOX1 and XC-TBOX-BD with related devices. If use TBOX1 and XC-TBOX-BD at the first time, set S3 switch to OFF (static IP address), connect the TBOX1 and XC-TBOX-BD with the Ethernet, configure them with XCPpro software. After finishing the setting for one TBOX, turn on S3 and continue setting next XC-TBOX-BD.
- (3) Configure the XC-TBOX-BD. Select the BD serial port.
- (4) Set the IP address:

T-BOX1: 192.168.0.1

XC-TBOX-BD2: 192.168.0.2

XC-TBOX-BD3: 192.168.0.3

XC-TBOX-BD4: 192.168.0.4

Please see the edit TBOX device window:

T-BOX1 parameters setting:



XC-TBOX-BD 2 parameters setting:

Communication **Master/Client** TBOX Comment

**Login in**

Name:

Device ID:

**Serial Port**

Baudrate:

Databits:

Stopbits:

Parity:

Protocol:

**Remote Login in**

IP:  Port:

Server 2 Name:

**Config Network**

IP Address:  Port:

Mask Code:

Gateway:

DNS:

Device Type:TBox\_Slave

Communication **Master/Client** TBOX Comment

**Master Mode**

Protocol:

Station Num	IP

Station
1

**Client Mode**

Send Delay(ms):

Station Num
1



XC-TBOX-BD4 parameters setting:

Communication Master/Client TBOX Comment

**Login in**

Name:

Device ID:

**Serial Port**

Baudrate:

Databits:

Stopbits:

Parity:

Protocol:

**Remote Login in**

IP:  Port:

Server 2 Name:

**Config Network**

IP Address:  Port:

Mask Code:

Gateway:

DNS:

Device Type:TBox\_Slave

Communication Master/Client TBOX Comment

**Master Mode**

Protocol:

Station Num	IP

Station
3

**Client Mode**

Send Delay(ms):

Station Num
3

---

Then click write to TBOX. The following steps please refer to “Using step”. Now the XC-TBOX-BD parameters setting are finished.

## 8. XC-WT-BD

### 8.1 Summarization

XC-WT-BD is the expansion BD board of XC series PLC. It can test the 0~39.0625mV voltage signal from pressure sensor, and transform the voltage to digital value.

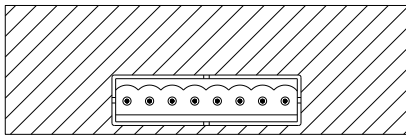

- Collect one channel pressure sensor signal
- Test voltage range is 0~39.0625mV
- 16-bit A/D transformation

### 8.2 Specifications

Analog input	DC 0~39.0625mV
Digital output	0~65535
Resolution	0.596uV
Transformation speed	20ms/channel
Working ambient	No corrosive gas
Ambient temperature	0°C~60°C
Storage temperature	-20~70°C
Ambient humidity	5~95%
Storage humidity	5~95%

### 8.3 Terminals

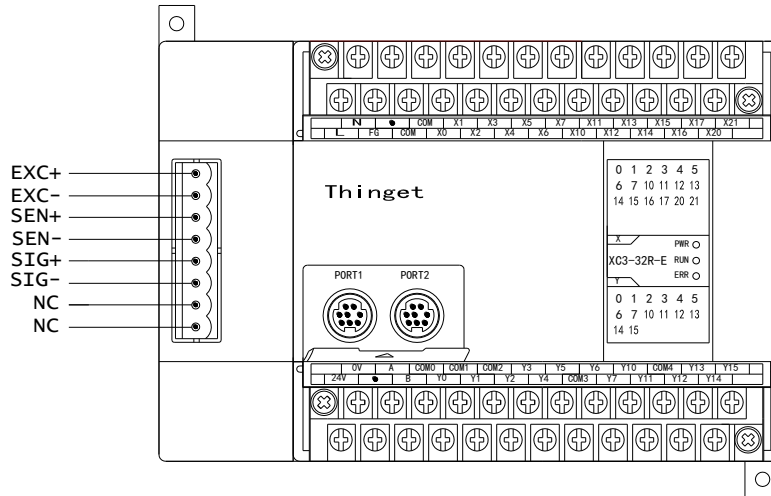

Terminal	Name	Meaning
EXC+	Weighing sensor power +	EXC+, EXC- connect to weighing sensor power terminal
EXC-	Weighing sensor power -	
SEN+	External reference input +	SEN+, SEN- connect to EXC+, EXC-
SEN-	External reference input -	
SIG+	Weighing sensor signal +	SIG+, SIG- connect to sensor signal output terminal
SIG-	Weighing sensor signal -	

Note: for real application, EXC+ connects to SEN+ and sensor power + (DC5V), EXC- connects to SEN- and sensor power -. SIG+ connects to sensor output +, SIG- connects to sensor output -.

### 8.4 Weighing system

A typical weighing system:

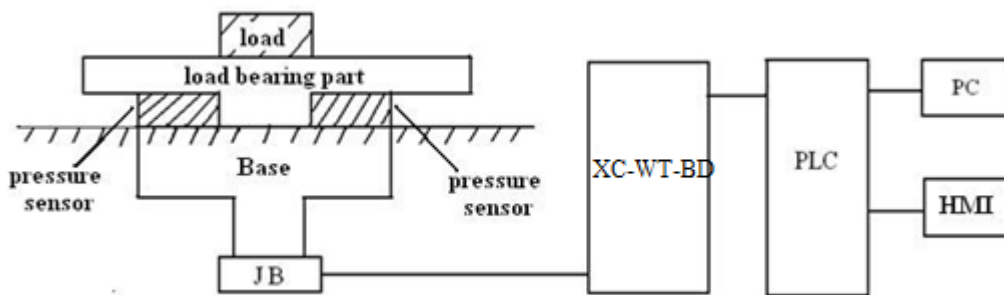

The weighing system contains:

**Loading bearing part:** to support the load. Such as flat, hopper, container, air transport car...

**Pressure sensor:** transform the weight to voltage signal.

**Assembly part:** make sure the pressure sensor can work correctly, assembly part and direct part can avoid overload. Overload will cause measurement error and sensor damage.



---

**Connection box (JB):** to collect several sensor signals.

**XC-WT-BD:** can be used as an electronic assessment device, it gets the pressure sensor signal and makes further assessment.

## 8.5 BD Configuration

Open the XCPpro software, connect PC with PLC and BD. Click configure/BD setting, open the BD set window.

Click “other BD” and choose the BD-WT. Then click ok and restart the PLC.

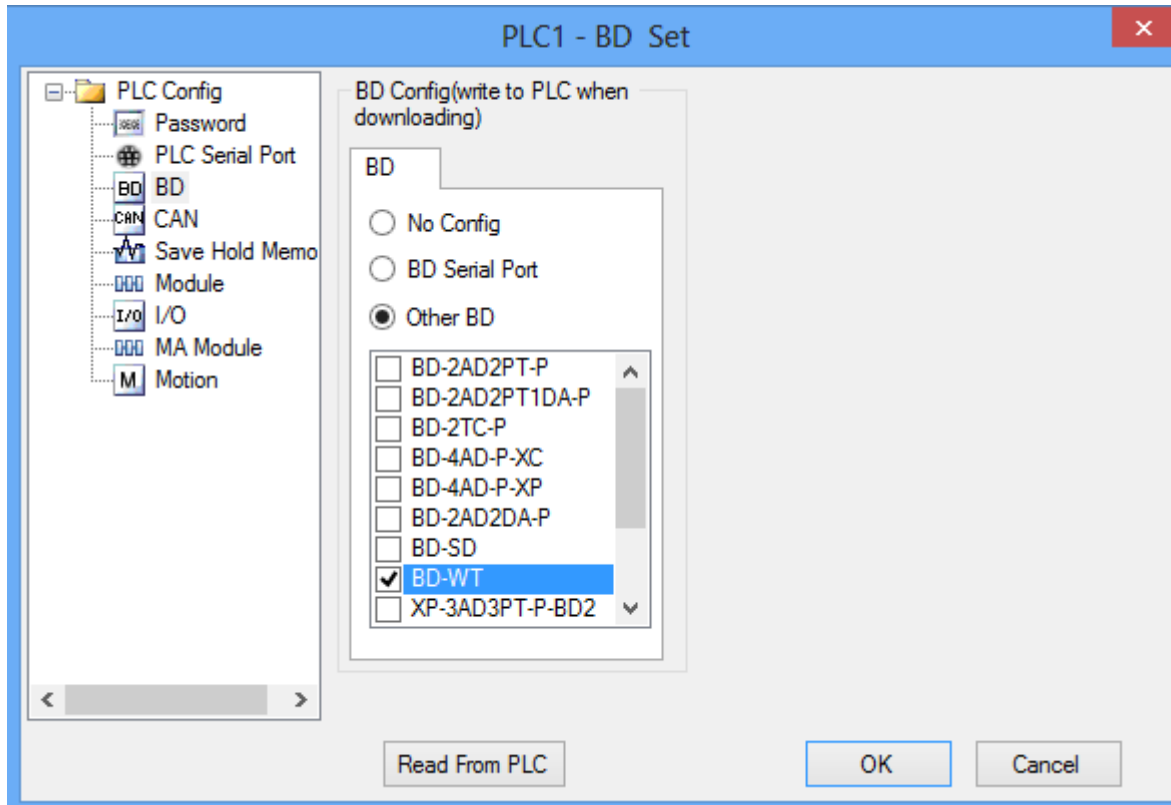

## 8.6 Pressure sensor

The pressure sensor is based on resistance strain effect, see the following diagram:

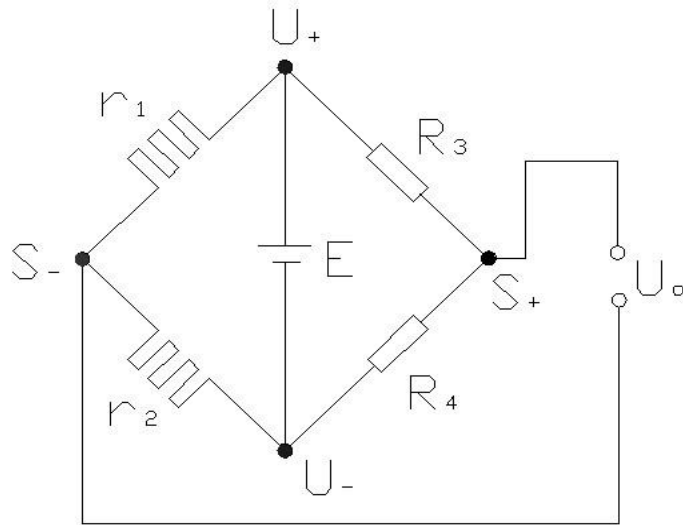

R1 and R2 is strain resistor which make bridge circuit with R3 and R4. With the change of R1 and R2, the bridge circuit will lose the balance, unbalance voltage  $U_o$  will be produced as the output of sensor.  $U_+$  and  $U_-$  are positive and negative point of the sensor power supply. Please select the 5V power of the module or from outside.

$S_+$  and  $S_-$  are positive and negative point of the sensor output. Connect the output to the module to test the weight.

### 8.7 A/D transformation diagram

The relationship between input voltage and converted digital value:

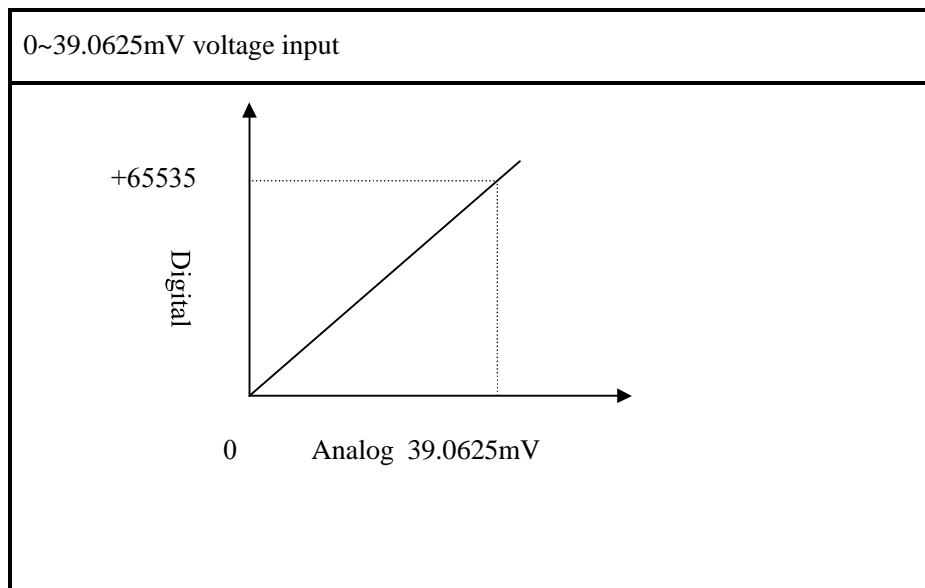

## 8.8 I/O address

XC-WT-BD will not occupy I/O address, the A/D transformed value will be stored in PLC register ID1000.

## 8.9 Programming example

Suppose the pressure sensor range is 0~100KG (the sensor output voltage range is 0~20.00mV). Display the weight (unit is kG) value in the HMI.

Program:

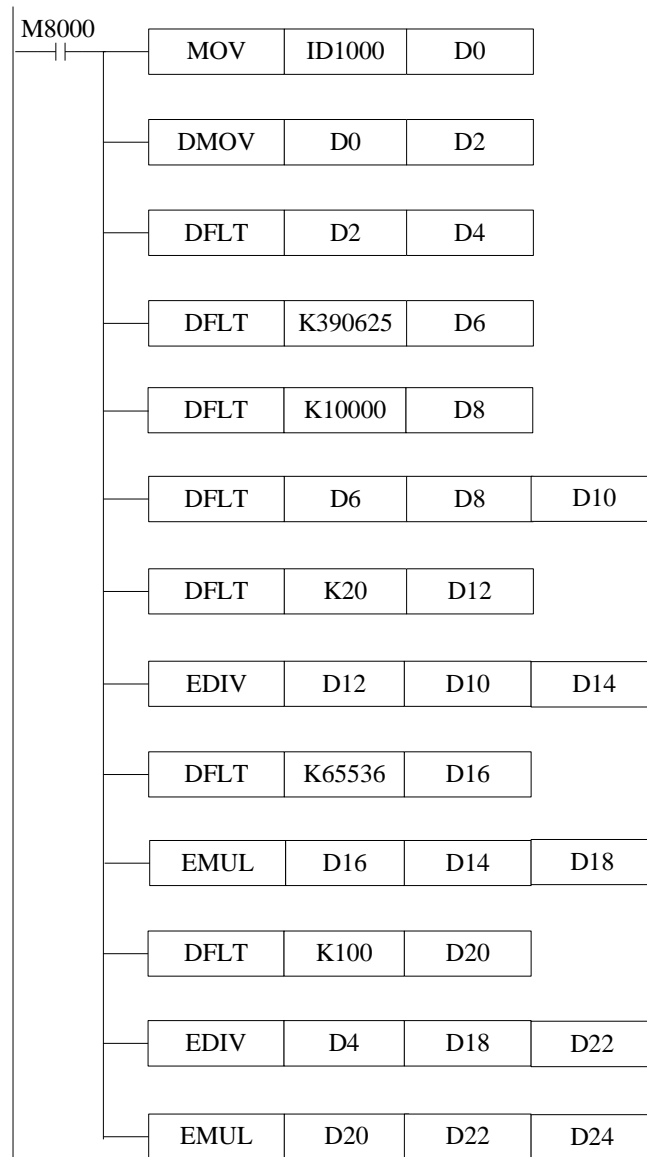

D4: real-time weight digital value (float number)

D10: the full-range analog value of XC-WT-BD (float number)

D14: (the full-range analog value of pressure sensor) ÷ (the full-range analog value of XC-WT-BD)

D18: the digital value range of XC-WT-BD (float number)

D22: (digital value) ÷ (weight) (float number)

D24: the real weight, unit is kG (float number)

## 9. XC-OFC-BD

### 9.1 Summarization

XC-OFC-BD has high baud rate and fast communication speed. The signal is transferred through light wave. Light wave has strong noise immunity ability; the max transmission distance is 1KM. It is easy to build the network, the slave station can up to 254.

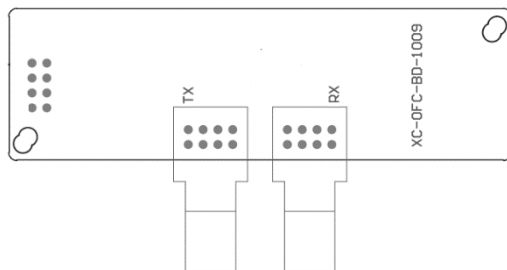

- TX: Fiber-optic communication send terminal
- RX: Fiber-optic communication receive terminal

### 9.2 Installation and wiring

#### (1) Installation

Open the left cover of PLC, install the BD board into the pins, fix it with the screws, and close the cover.

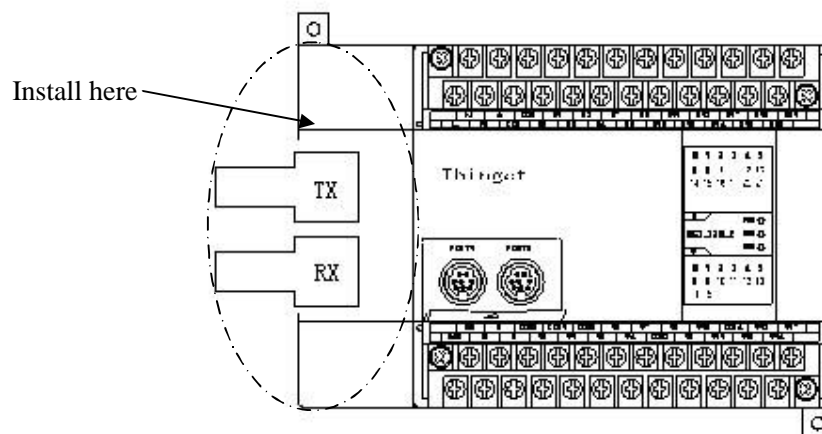

Please keep clean for the fiber optical terminal. Please put on the protection cover to prevent pollution.

#### (2) Wiring

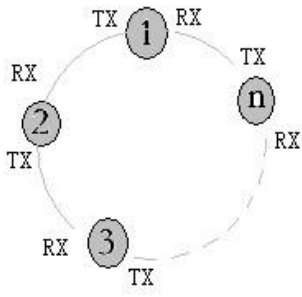
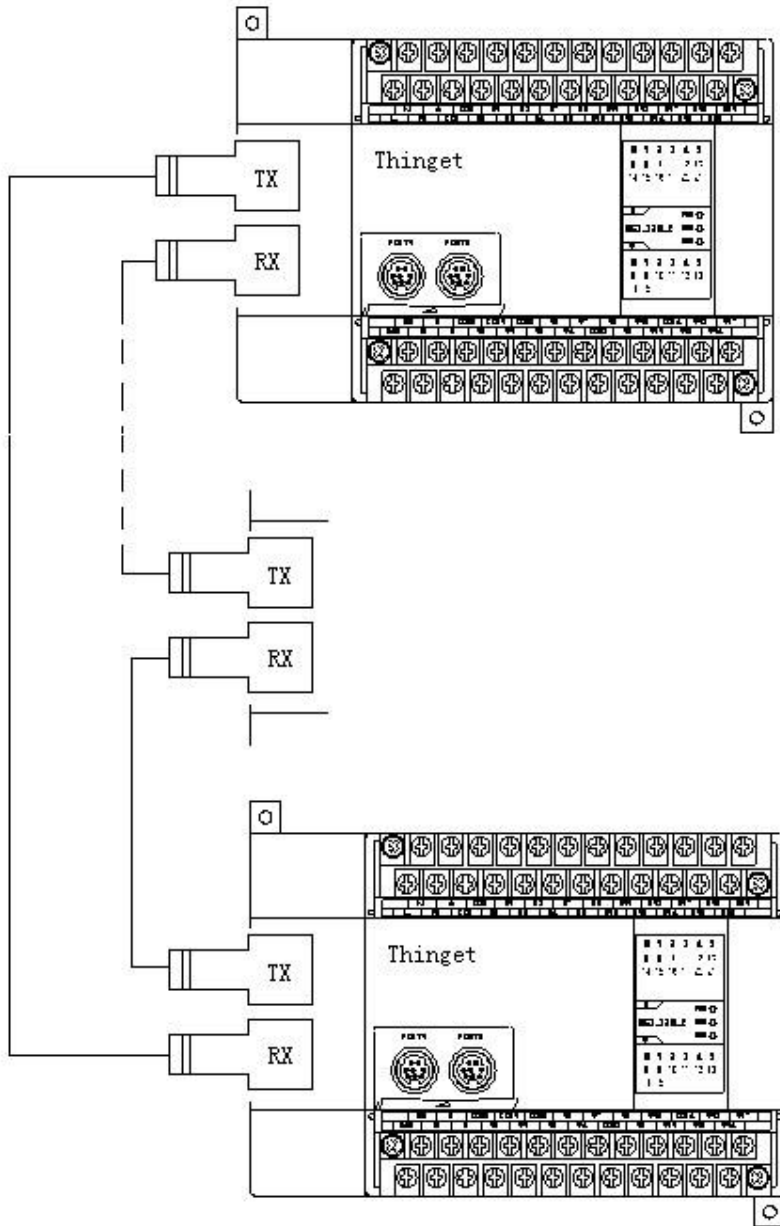

Connect TX with RX as the above diagram, make all the PLC in a loop.

### 9.3 Configuration and settings

#### (1) BD board settings

Connect the PLC with XC-OFC-BD to the PC, open XCPpro software, choose BD serial port. Please restart the PLC after setting. Then download user program.

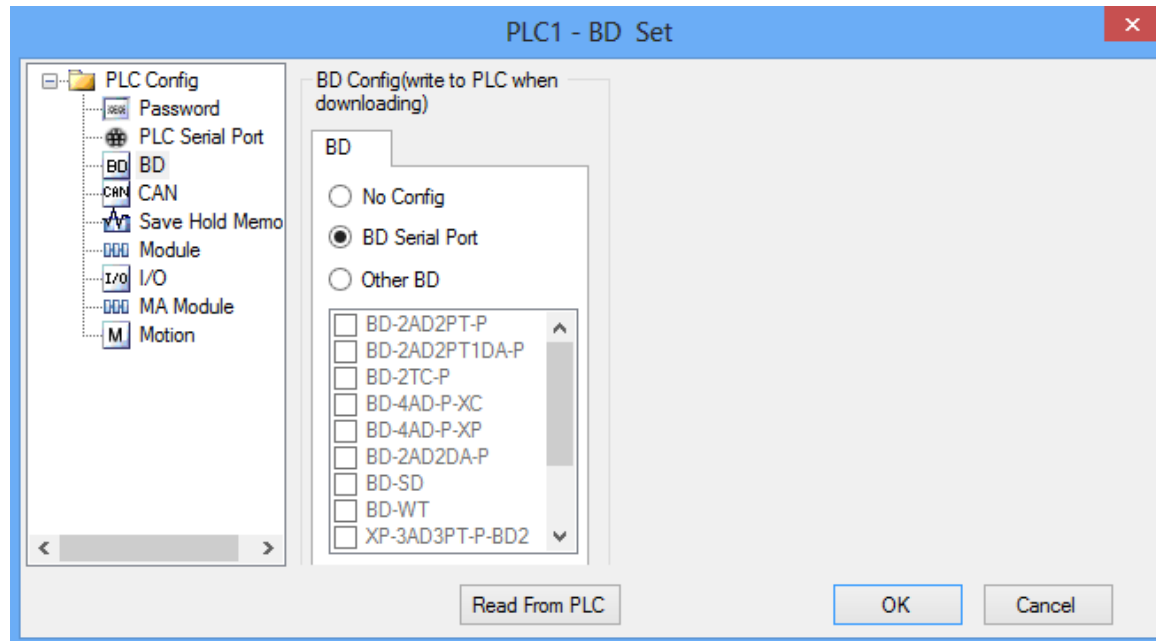

#### (2) Serial port settings

XC-OFC-BD will occupy serial port3 of PLC; it needs to set the port3 in XCPpro software:

- (A) The baud rate of all the port3 in the network must be the same.
- (B) The station number of all the port3 in the network should be different.
- (C) XC3/XC5 support the follow baud rates:

600Hz,1200Hz,2400Hz,4800Hz,9600Hz,19200Hz,38400Hz,57600Hz,115200Hz,192000Hz,  
288000Hz, 384000Hz, 576000Hz

- (D) XC2/XCM/XCC support the follow baud rates:

600Hz,1200Hz,2400Hz,4800Hz,9600Hz,19200Hz,38400Hz,192000Hz,256000Hz,384000Hz,  
512000Hz, 768000Hz

Please see the settings in XCPpro software:

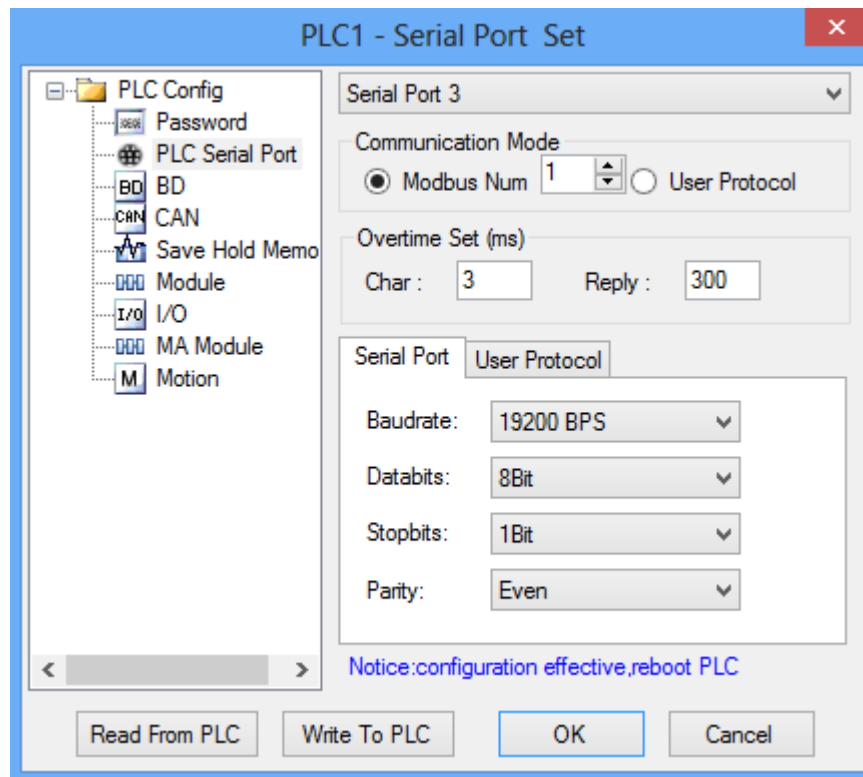

Please set the suitable parameters, click write to PLC, then download an empty program into the PLC. Finally, re-power on the PLC to make it effective. (make sure to choose serial port3 when setting)

Note: serial port 1 parameters cannot be changed, otherwise PLC cannot communicate with XCPpro software.

## 10. XC-PBOX-BD

### 10.1 Summarize

XC-PBOX-BD can be the slave station of Profibus DP. It realizes the interconnection between XC series PLC and Profibus DP system.

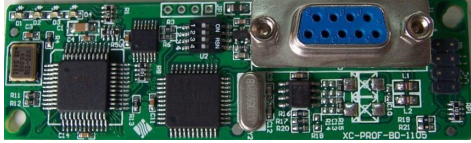

- The theoretical address range of Profibus: 0~127, 127 is broadcast address.
- Up to 32 master stations can be used. The station amounts can up to 127.
- The station No. of XC-PBOX-BD should be in the range of 1-255 and in accord with the slave station no. of Profibus.

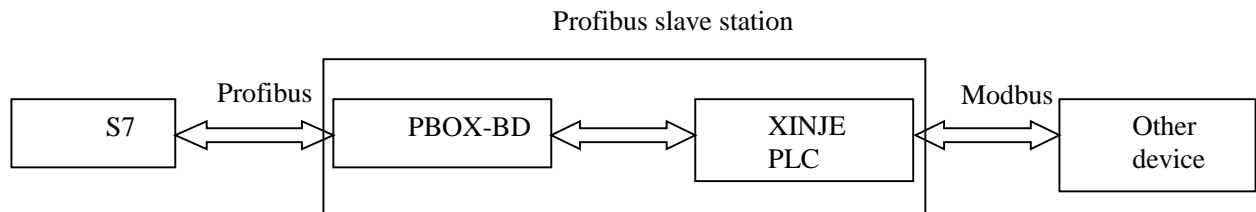

### 10.2 Terminal resistor

Both ends of the Profibus cable should connect terminal resistor. The terminal resistor can clear the signal reflection in the cable which is caused by resistor discontinuity and mismatching.

There are two reasons for the signal reflection: the resistance discontinuity and impedance mismatch.

Resistance discontinuity: The signal suddenly encounter little or no (eg short circuit) or high resistance (example: open circuit) at the end of the transmission line, the signal will cause reflections in this place.

The both ends of the cable must be connected with resistors whose impedance is same to the cable to make the resistance of the cable continuously.

Impedance mismatch: when the communication cable is in standby mode, the entire network data are orderless. The noise suppression or bias resistors can reduce the effect of reflection signal.

Thus, the terminal resistor is ON when it is connecting the last station. All the other terminal resistors are OFF.

### 10.3 Installation and configuration

(1) Open the cover on the left of the PLC, insert the BD into the pins, fix it with the screws and close the cover.



Install here

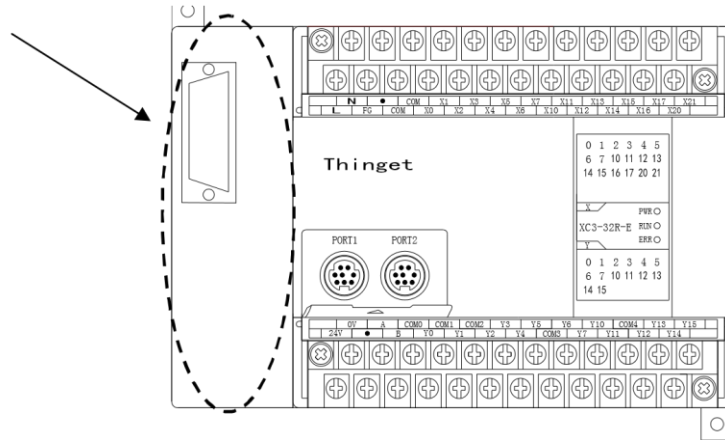

(2) Connect the PLC installed XC-PBOX-BD to the XCPpro software. In the XCPpro software, click “configure/BD settings”:

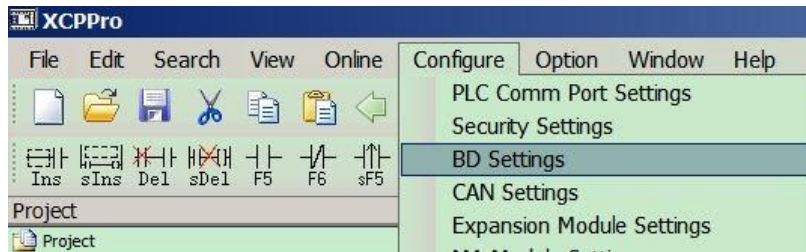

(3) Choose “BD serial port”:

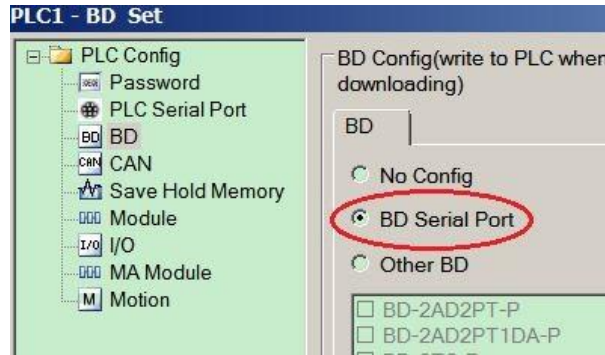

(4) Click “PLC serial port”, choose serial port 3. The modbus num should be the same to Profibus slave station no. click “write to PLC”, then download program. Cut the PLC power and power on again, then run the PLC.

Note: the station no. of PLC serial port 3 must be equal to Profibus slave station no. (XC-PBOX-BD station no.) The PLC station no. range is from 1 to 255.

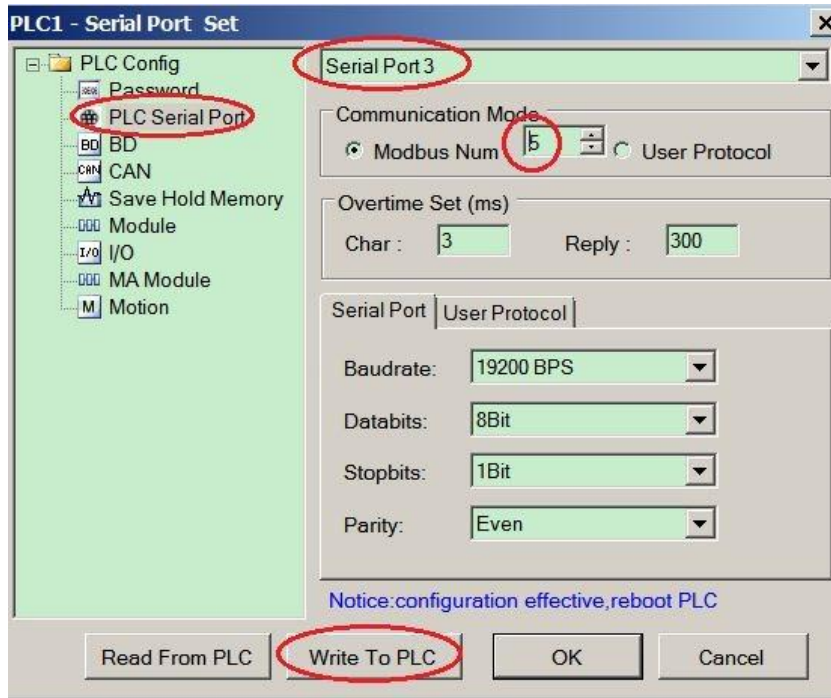

## 10.4 Wiring

The DB9 port of XC-PBOX-BD is the standard Profibus terminal, please see the terminal definition:

XC-PBOX-BD		Profibus DP device	
Pin	Name	Pin	Name
1			
2			
3	B		(RxD/TxD P)
4			
5	D-GND		GND
6	VP(+)		VCC
7			
8	A		(RxD/TxD N)
9			

XC-PBOX-BD Profibus DP device

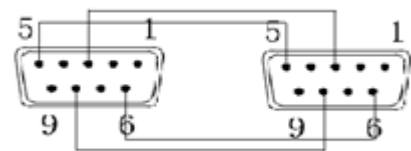

5—GND and 6—VCC provide power for terminal resistor. If there is no terminal resistor, please do not connect them.

## 10.5 DIP switch

Please set the baud rate of communicating between XC-PBOX-BD and Xinje PLC via DIP switch.

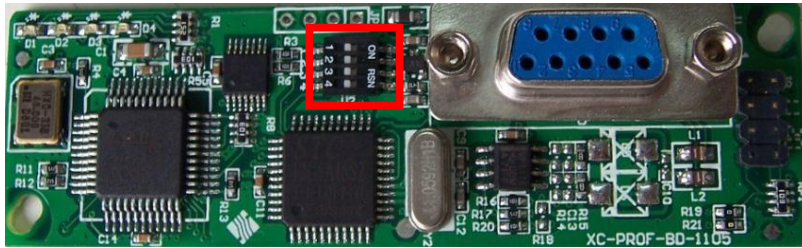

Baud rate (bps)	DIP1	DIP2	DIP3	DIP4
19200	OFF	OFF		
9600	OFF	ON		
38400	ON	OFF		
115200	ON	ON		

Note:

1. The default communication parameter is: 8 data bit, 1 stop bit, even parity.
2. Only DIP switch 1 and 2 are valid, 3 and 4 are invalid.

## 10.6 LED

There are four LED lights on the XC-PBOX-BD.

D4: the light flashes when reading the station No. of PLC serial port3, it always lights when got the station No.

D3: the state of Profibus.

D2: it lights when data is being sent.

D1: it lights when data is being received.

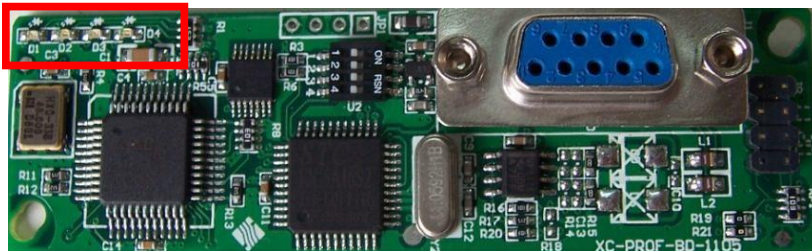

## 10.7 Operation steps

Please do the following operations if the master station of XC-PBOX-BD is Siemens Profibus-DP device.

- Copy XC-PBOX.GSD to the route of `\\.\Step7\S7data\gsd\`
- Copy Xinje\_B.bmp to the route of `\\.\Step7\S7data\nsbmp\`

If the master station is not Siemens products, please copy XC-PBOX.gsd and Xinje\_B.bmp to the folder of gsd and bmp.

Now we take Siemens S7-300 series PLC (315-2AH14-0AB0) as an example to explain the debug process. Suppose the S7-300 sets ON M0-M7 of Xinje PLC via XC-PBOX-BD. And set double word register (D0,D1) to 12345678, set (D3,D4) to 87654321. And read the value of M20-27 and (D100, D101)(D102, D103).

- (1) Open the Siemens simatic manager software, build a new project.
- (2) Name the project:

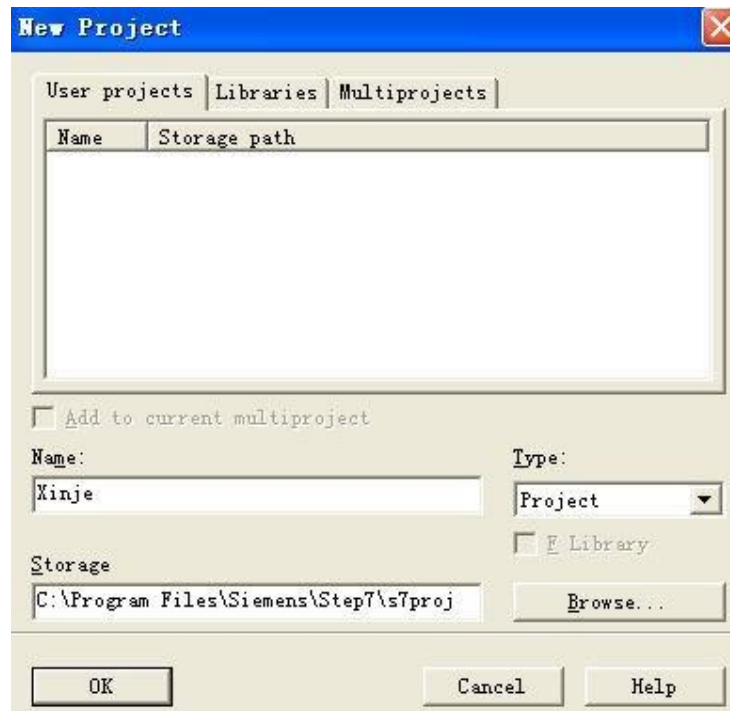

- (3) Insert new object/Simatic 300 station, name it as PBOXOPC:

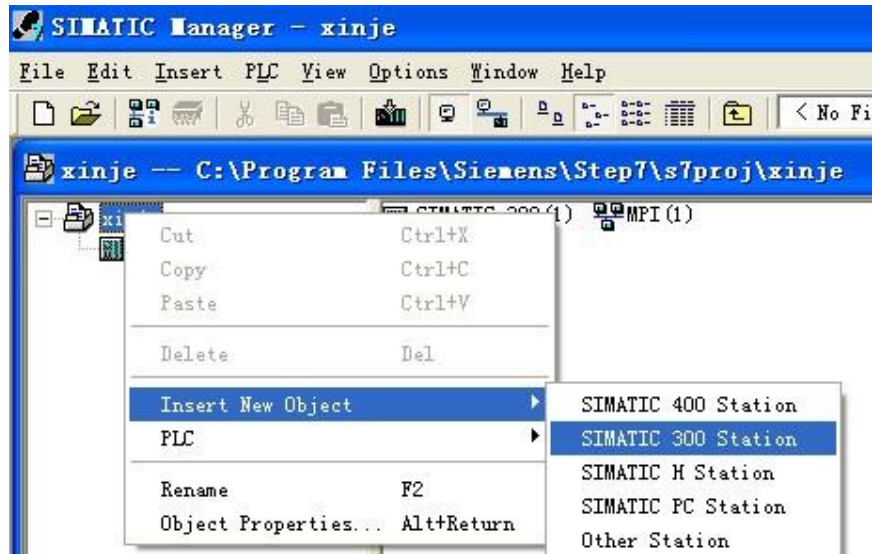

(4) Click PBOXOPC, it will show below window

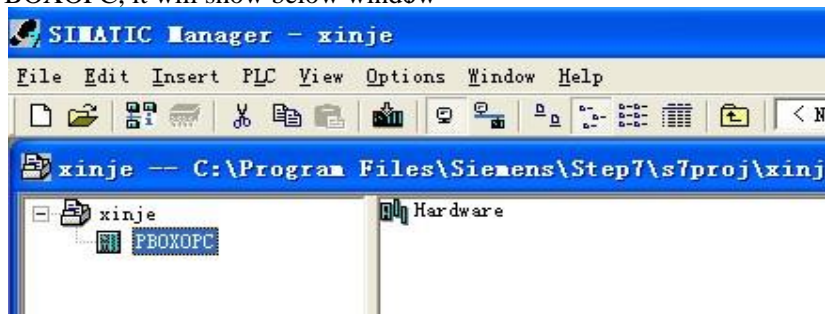

(5) Double click the hardware, you will see below window:

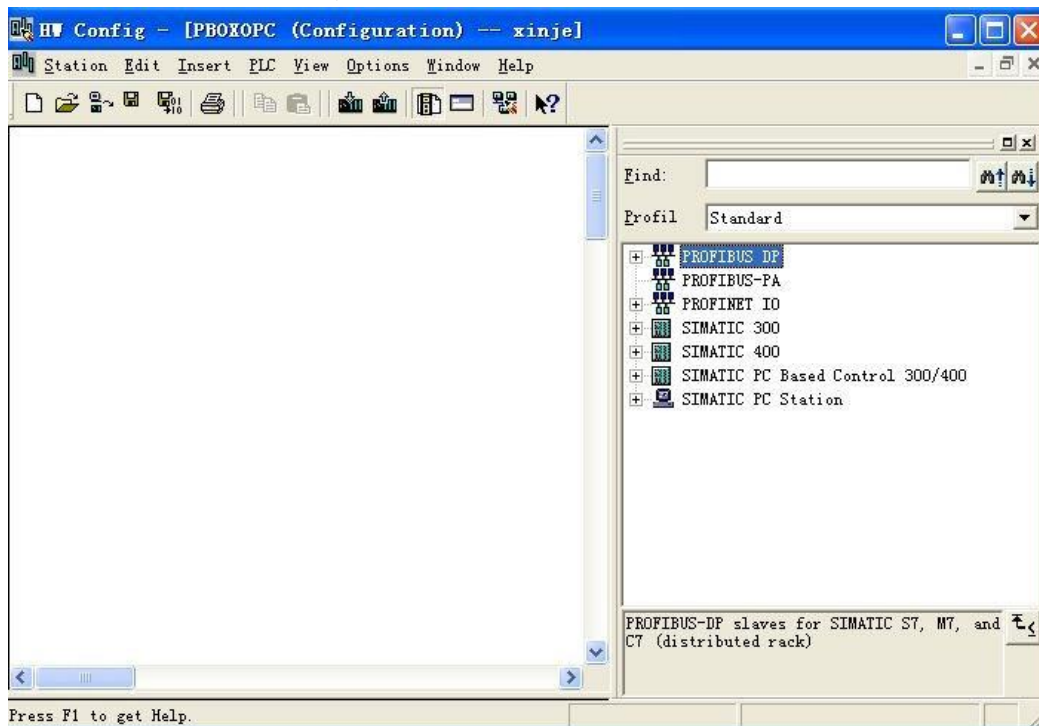

(6) Click Insert/insert object, it will show below window:

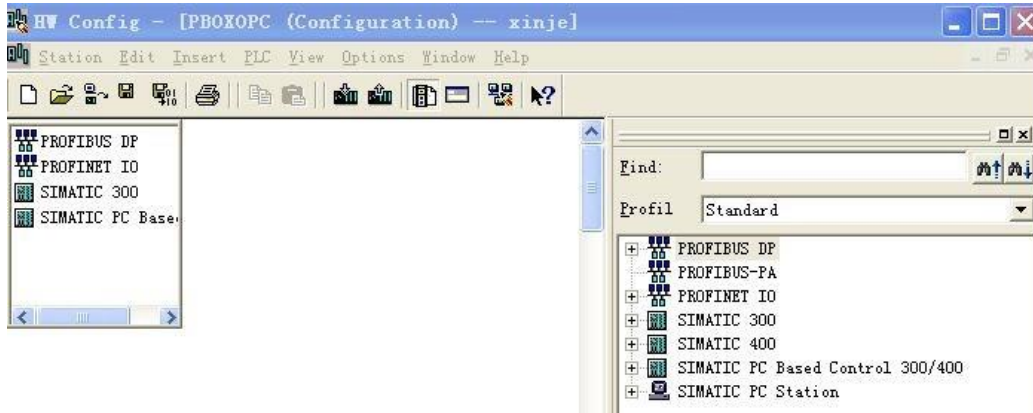

(7) Click “SIMATIC 300”, then click “RACK-300”, it will show below window:

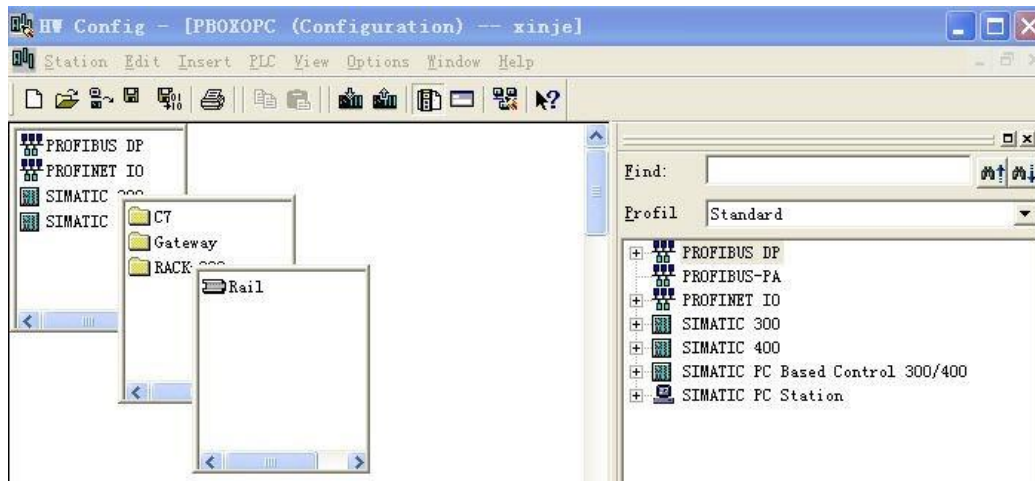

(8) Click Rail, it will show below window:

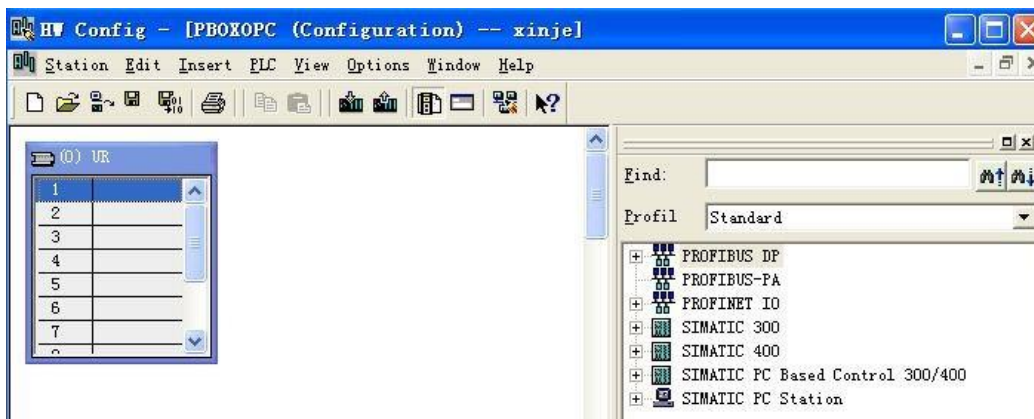

(9) Click Option/update catalog, then do the operations in below window:

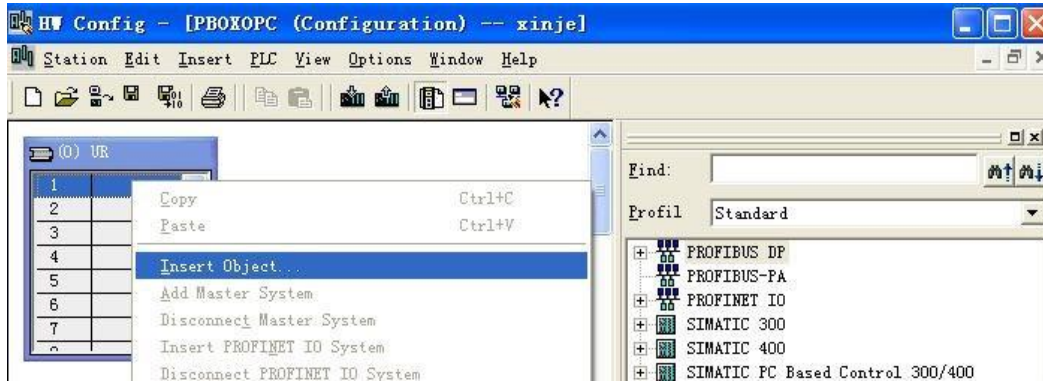

(10) Choose the matched power module for the PLC. Here we choose PS307 2A , CPU 315-2DP\6ES7 315-2AG10-0AB0\2.6:

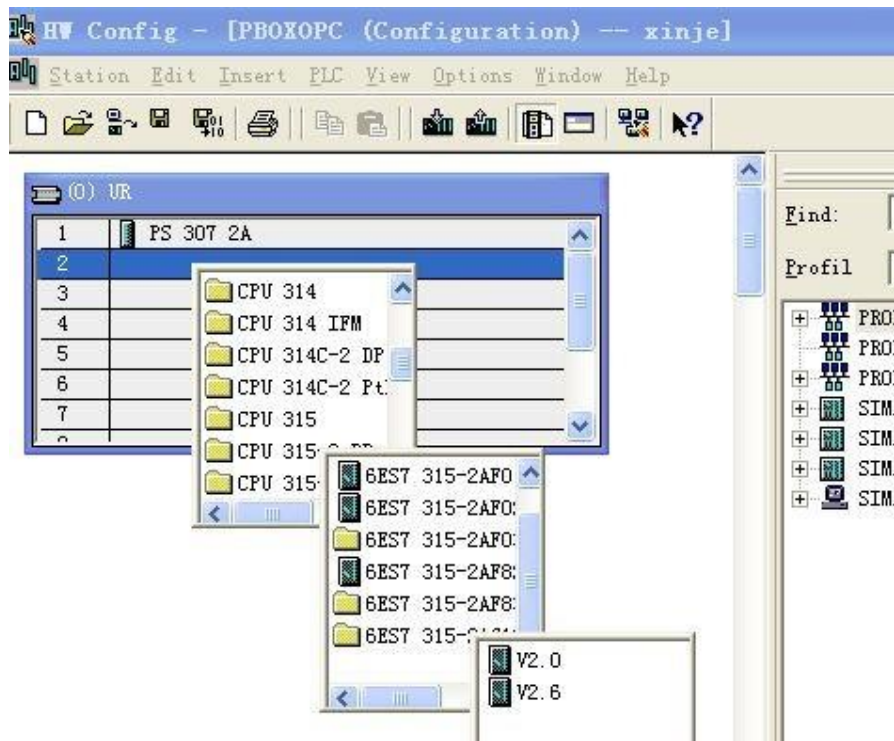

(11) Click v2.6, it will show below window, choose the master station (S7-300) No. of XC-PBOX-BD, here we choose 2. Then click “New...” button in the window:

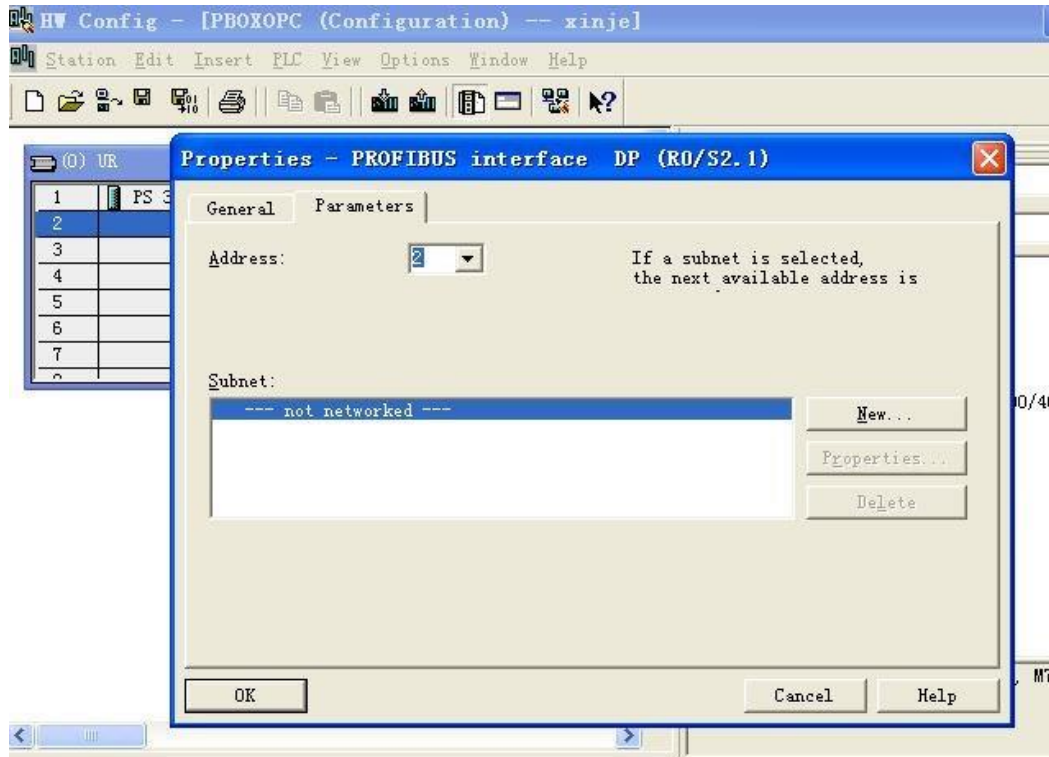

(12) Click “Network settings”, set the transmission rate to 12Mbps.



(13) Click PROFIBUS (1): DP master system (1), then choose “ProfibusDP\ Additional Field Devices Gateway\ PBOX”, double click PBOX, then set the slave station No. of PBOX to 5.





(14) As the chapter 1 said, we copy the file XC-PBOX.GSD to `.\Step7\S7data\gsd\`, and copy the file `Xinje_B.bmp` to `.\Step7\S7data\nsbmp\`, now we can see the Xinje station picture in the below window:

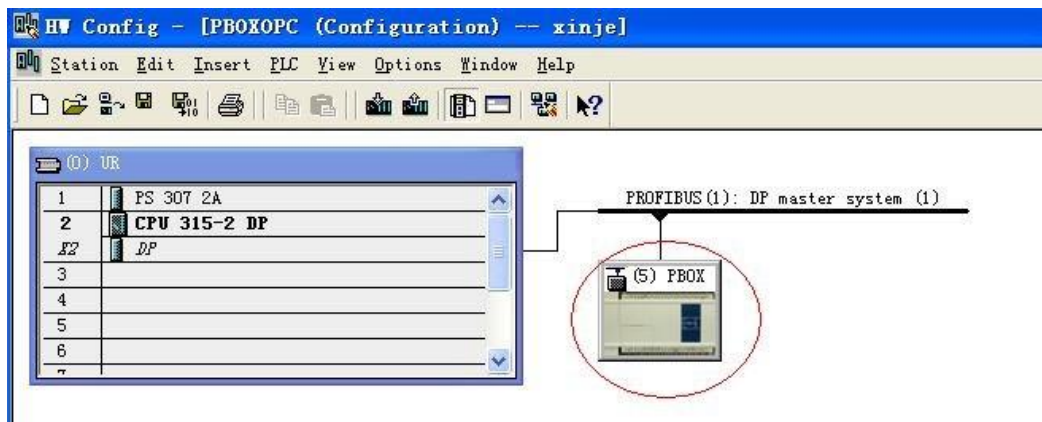

(15) double click the Xinje station picture, it will show below window. Set the data update mode: At every MD end or At MD scan end.



(16) Configure the read and write.

Read: read the value of Xinje PLC to Profibus.

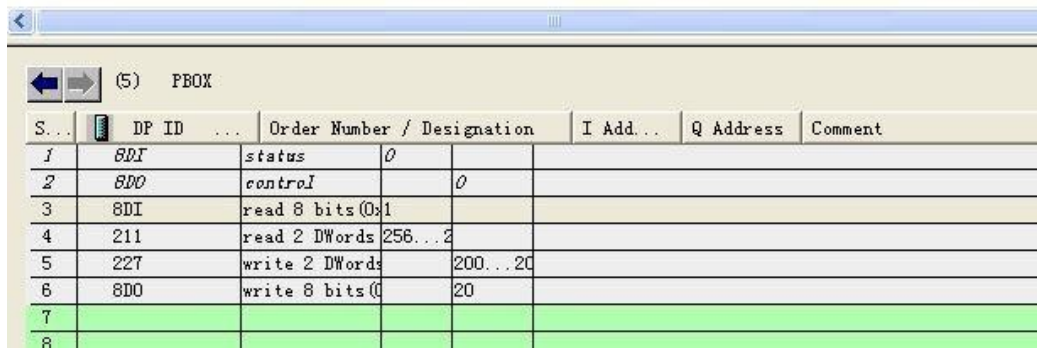
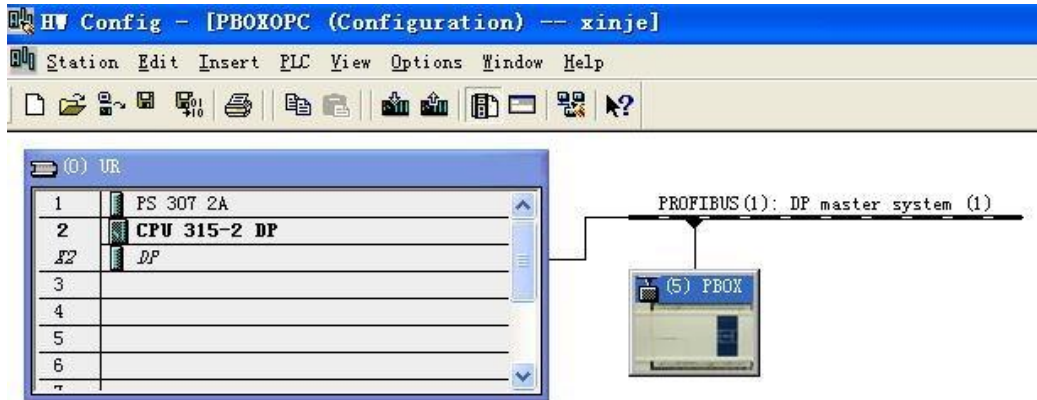

Write: write the value of Profibus to Xinje PLC.

Force single bit and Set single word: write the value of Profibus to Xinje PLC.

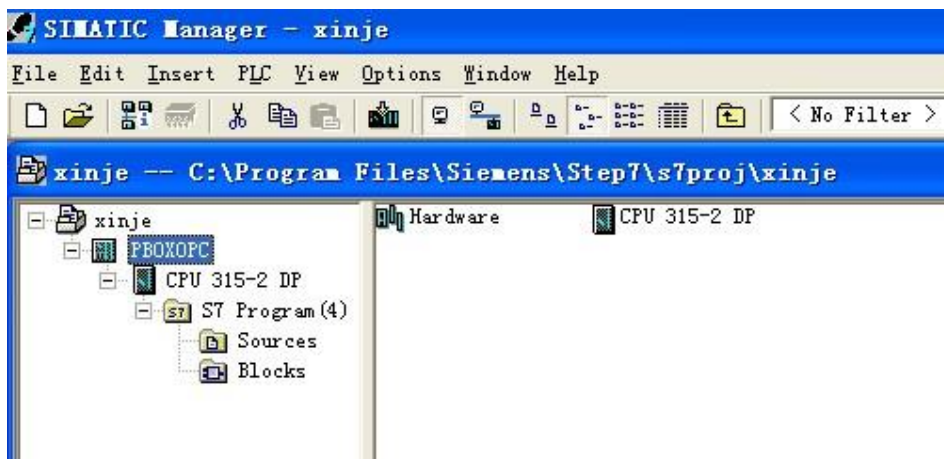

(17) After making the program, click save and compile , then click download to module . Return to below window:



(18) click "Blocks", it will show , double click OB1, it will show below window, then click  enter programming window Then make the program in it.

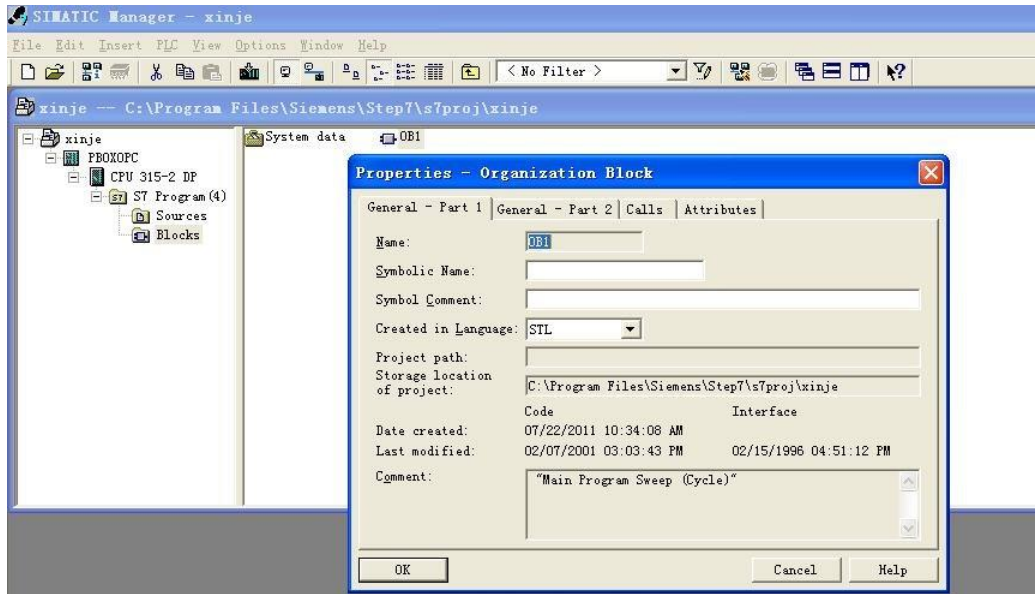

Programming window:

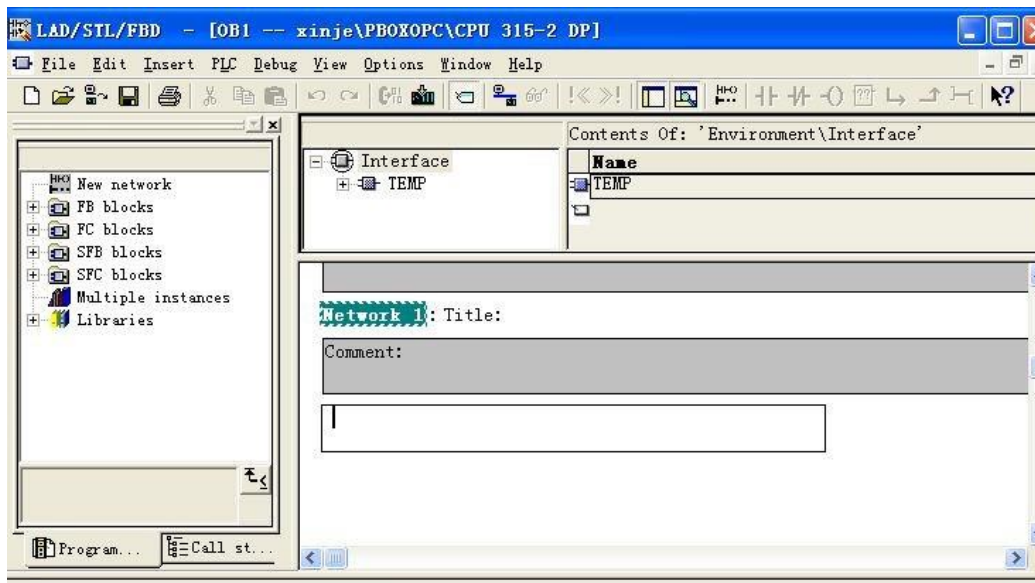

Program:

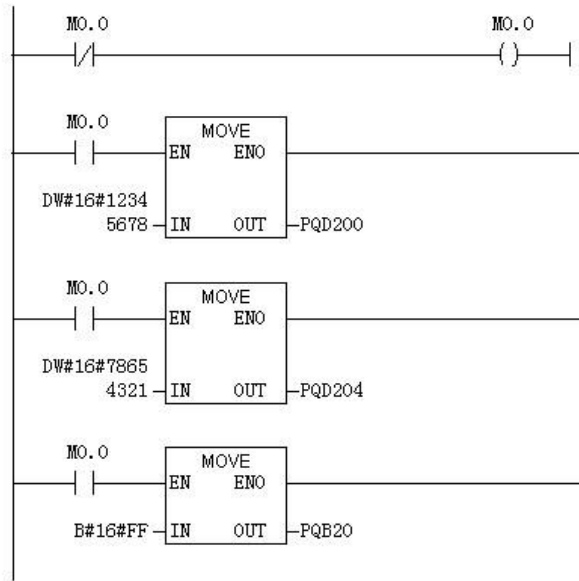

(19) After making the program, save and download to the module. Turn On the RUN switch of S7-300. The SF BF LED is OFF on the S7-300, it means the communication is successful. Then turn off the RUN switch. Now please open the XCPpro software, connect it to the Xine PLC with XC-PBOX-BD (please configure the



XC-PBOX-BD at first in the software). Click free monitor , add the data in the monitor list (see figA).

Then turn on RUN switch of S7-300, the monitor data is shown in figB. (M20-M27,D100 D102 are the data write from S7-300 to XC series PLC.

M0	ON
M1	OFF
M2	ON
M3	OFF
M4	ON
M5	OFF
M6	ON
M7	OFF
M20	OFF
M21	OFF
M22	OFF
M23	OFF
M24	OFF
M25	OFF
M26	OFF
M27	OFF
D0	12345678
D2	87654321
D100	00000000
D102	00000000

FigA

M0	ON
M1	OFF
M2	ON
M3	OFF
M4	ON
M5	OFF
M6	ON
M7	OFF
M20	ON
M21	ON
M22	ON
M23	ON
M24	ON
M25	ON
M26	ON
M27	ON
D0	12345678
D2	87654321
D100	12345678
D102	78654321

FigB

(20) Monitor the data of S7-300. Right click the data needs to monitor:

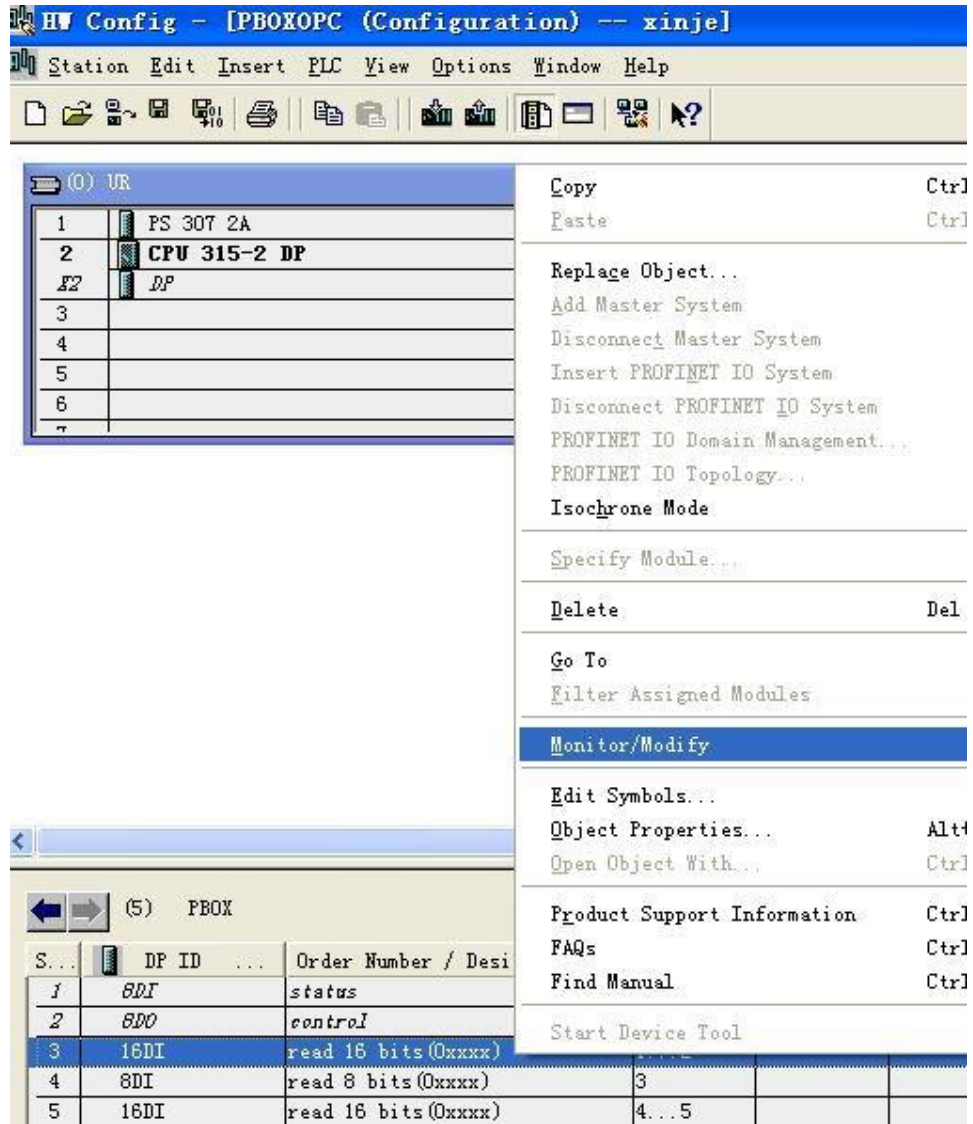

(21) Choose "monitor" to see the data. The data are the same to the setting data in XC series PLC.

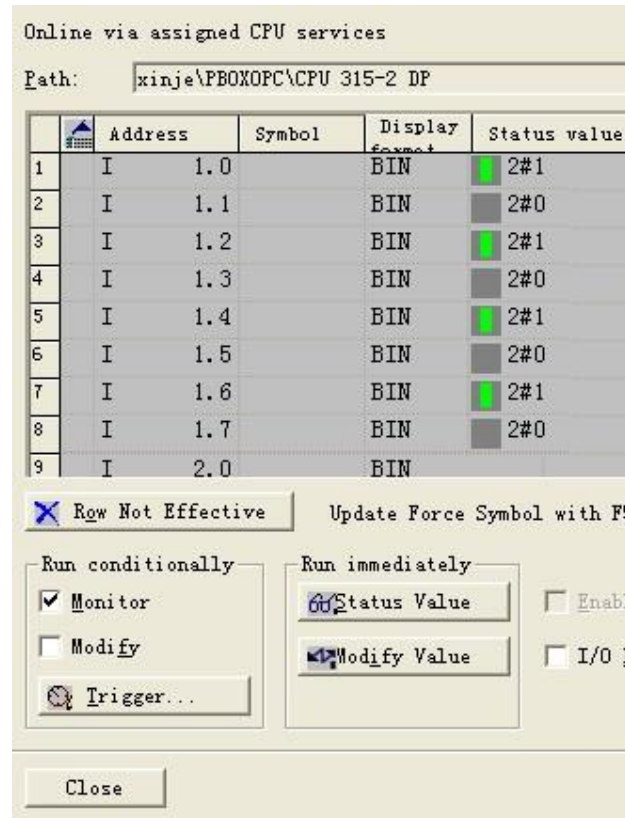

(22) Monitor the Read 2 Dwords with the same way

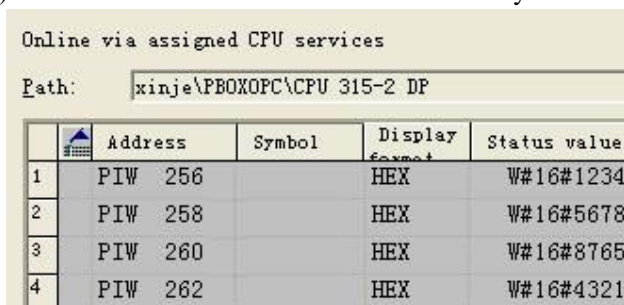

Notes:

1. The Xinje PLC only can be slave station with XC-PBOX-BD. XC-PBOX-BD only can be used with Xinje PLC. Please choose the Xinje PLC which can expand BD module.
2. After configuration of the XC-PBOX-BD, please re-power on it.
3. The station No. in the PLC should be accord to the Profibus slave station No., especially for SCADA application.

The logo for XINJE, featuring the word "XINJE" in a bold, blue, sans-serif font. The letters are closely spaced and have a slight shadow effect.

**WUXI XINJE ELECTRIC CO., LTD.**

4th Floor Building 7, No.100 Dicui Road,  
Wuxi City, China

Tel: (510) 85134136

Fax: (510) 85111290

Web:[www.xinje.com](http://www.xinje.com)

Email: [cheerfiona@gmail.com](mailto:cheerfiona@gmail.com)