

DISTRIBUIDOR AUTORIZADO.

www.imservo.com

ventas1@imservo.com / ventas2@imservo.com

QUITO-GUAYAQUIL

ECUADOR



Human Machine Interface



MTG/TG/TE/TH/OP/MP Series



HMI Rich product models

MTG series
TG series
TE series
TH series
OP series
MP series

- The perfect combination of specialization and humanization, lead the new concept of HMI.
- 4.3 inches to 15.6 inches.
- 16.77 million colors, exquisite image quality, the display effect is comparable with LCD.
- High speed response for downloading, startup, running.
- Support C language, free format protocol, programming freely.
- Rich 3D library makes the screen vividly.



Handheld wireless MTG765-UT

- 16.77 million colors, resolution 800*480, 7 inches wide screen.
- Delicate appearance, handheld operation, more flexible.
- Wireless communicate with PLC, the max speed is 115200bps, the distance can up to 150m, more stable.
- Built-in mobile power supply, easy to charge, long battery life.
- Built-in flash disk interface supports data import export and program import.
- High speed response for downloading, startup, running.
- Powerful software can make complicated screen.
- Easy to programming and operate, fit for various applications.



Appearance

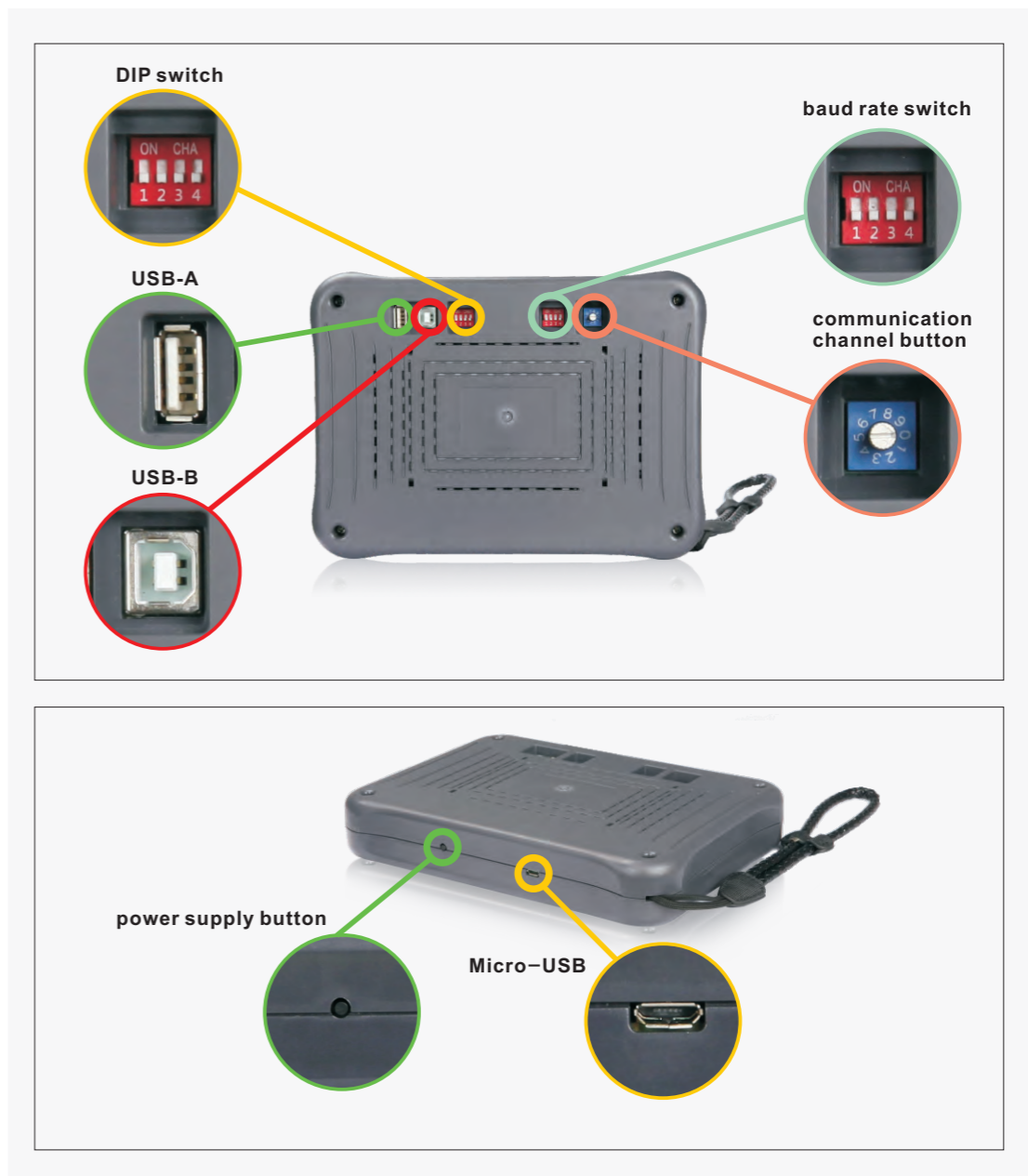

Networking communication



Product specification

HMI specification

Item	MTG765-UT
LCD	7.0"
Colors	16.77 million
Resolution	800*480
Brightness	Adjustable (PFW100)
Touch panel	4-wire resistor touch panel
Using life	Up 50000 hours, ambient temperature 25°C, 24 hours running
Language	Chinese, English, Japanese, Korean, German, Russian...
Character size	Any font and size
Memory	Memory 128MB

Electrical specification

Item	MTG765-UT	
Electric	Power	4W
	Charging input parameter	5.0V-2.0A 9.0V-2.0A 12V-1.5A
	Battery life (always ON)	8 hours
	Charging time	< 10 hours
Ambient	Operation temperature	0 ~ 45°C
	Ambient humidity	10%RH-90%RH (no condensation)
	Air	No corrosive gas
	Protection	The front cover is accord to IP65
Structure	Cooling mode	Natural cooling
	Dimension (mm)	217.1*158.0*36.6
Interface	PLC port (built-in)	Built-in PLC port integrated wireless communication module
	USB port 1	USB-A (USB2.0), flash disk port
	USB port 2	USB-B (USB2.0), USB download port
	Micro-USB	Micro-USB, USB charging port

Dimension (unit: mm)

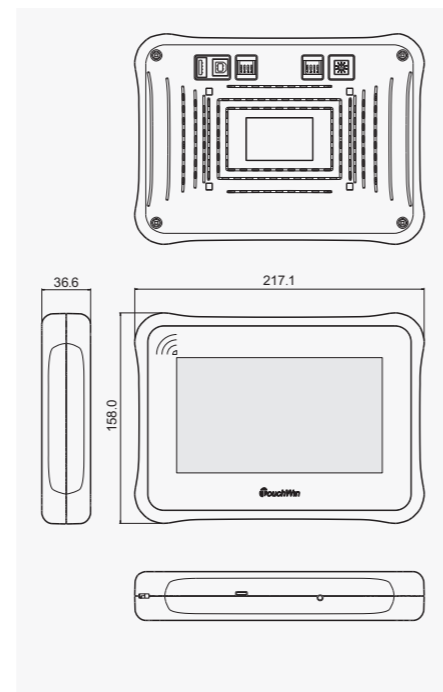

New generation of HMI TG/TE series

TG/TE series HMI has better hardware, faster response, good image quality and rich connectivity.

TG/TE series outstanding performance

Better hardware makes advanced products

- CPU is ARM9 400MHz
- Internal memory 128MB/64MB
- Memory 128MB
- Color 16.77 million

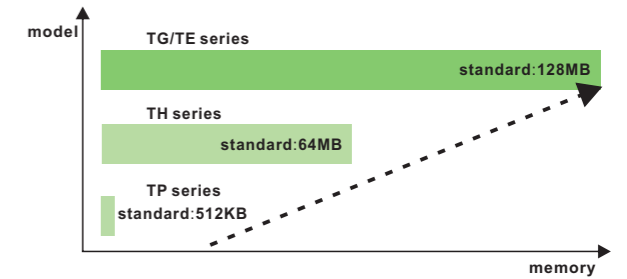

High speed response for downloading, start and running

- Download- USB faster data transmission, the speed is 5 times of TH series.
- Start- shorten the start time, improve the start speed.



- Run- smooth effect for screen switching and animation.

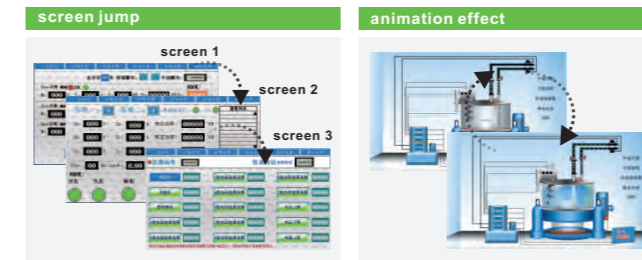

- larger power-off retentive range, about 4 million words can be used.

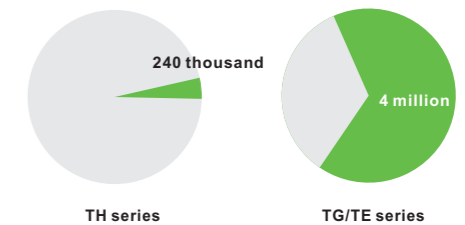

From single HMI to network communication

Support Ethernet communication, improve the communication speed, fit for complicated environment.

- Standard RJ45 Ethernet port
- Construct the open network with Modbus-TCP devices, Siemens S7-1200, Mitsubishi Melsec, T-BOX, G-BOX

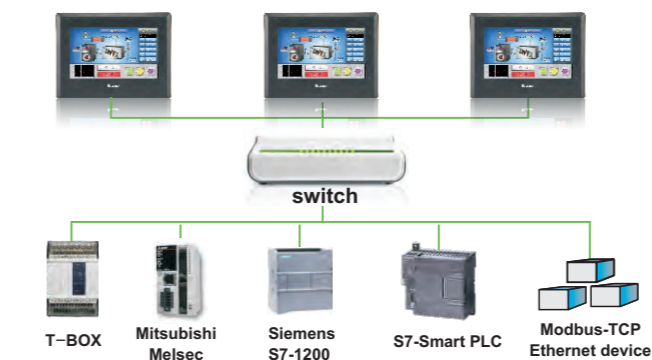

Support X-NET fieldbus, the communication mode includes one HMI one device, one HMI multi-device, multi-HMI one device, multi-HMI multi-device, the max speed can up to 3M.

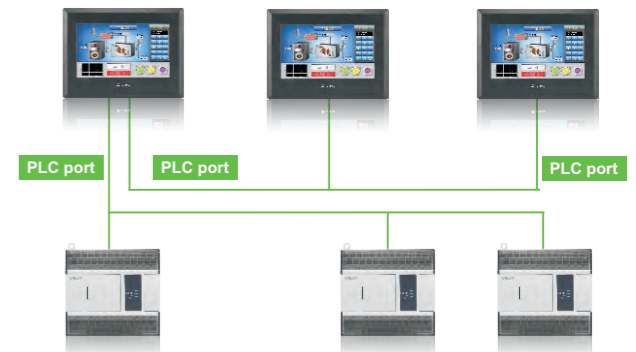

Pass through function, remote upload and download program via HMI, monitor the PLC state



Cover all the functions of TH series



Rich products, complete specifications, meet all your requirements

Best hardware configuration, high speed response, high display quality, from single device to networking, cover all the functions of TH series.

X-NET fieldbus - NT series

10.1 inches
TGA63-NT



- ◆ 16.77 million colors, TFT LCD, LED backlight
- ◆ Resolution 1024*600
- ◆ Memory 128MB
- ◆ Two serial ports
Download port: RS232, RS485, RS422
PLC port: RS485
- ◆ Model explanation:
NT: USB-A port, USB-B port, Ethernet port

8 inches
TG865-NT



- ◆ 16.77 million colors, TFT LCD, LED backlight
- ◆ Resolution 800*480
- ◆ Memory 128MB
- ◆ Two serial ports
Download port: RS232, RS485, RS422
PLC port: RS485
- ◆ Model explanation:
NT: USB-A port, USB-B port, Ethernet port

7 inches
TG765-NT



- ◆ 16.77 million colors, TFT LCD, LED backlight
- ◆ Resolution 800*480
- ◆ Memory 128MB
- ◆ Two serial ports
Download port: RS232, RS485, RS422
PLC port: RS485
- ◆ Model explanation:
NT: USB-A port, USB-B port, Ethernet port

Advanced model - TG/TE series

15.6 inches
TGC65-ET



- ◆ 16.77 million colors, TFT LCD, LED backlight
- ◆ Resolution 1366*768
- ◆ Memory 128MB
- ◆ Two serial ports
Download port: RS232, RS485
PLC port: RS232, RS485, RS422
- ◆ Model explanation:
ET: USB-A port, USB-B port, Ethernet port

10.1 inches
TGA63-MT/UT/ET



- ◆ 16.77 million colors, TFT LCD, LED backlight
- ◆ Resolution 1024*600
- ◆ Memory 128MB
- ◆ Two serial ports
Download port: RS232, RS485
PLC port: RS232, RS485, RS422
- ◆ Model explanation:
MT: USB-B port UT: USB-A port, USB-B port
ET: USB-A port, USB-B port, Ethernet port

10.1 inches
TGA62-MT/ET



- ◆ 16.77 million colors, TFT LCD, LED backlight
- ◆ Resolution 800*480
- ◆ Memory 128MB
- ◆ Two serial ports
Download port: RS232, RS485
PLC port: RS232, RS485, RS422
- ◆ Model explanation:
MT: USB-B port
ET: USB-A port, USB-B port, Ethernet port

8 inches
TG865-MT/ET



- ◆ 16.77 million colors, TFT LCD, LED backlight
- ◆ Resolution 800*600
- ◆ Memory 128MB
- ◆ Two serial ports
Download port: RS232, RS485
PLC port: RS232, RS485, RS422
- ◆ Model explanation:
MT: USB-B port
ET: USB-A port, USB-B port, Ethernet port

7 inches
TG/TE765-MT/UT/ET



- ◆ 16.77 million colors, TFT LCD, LED backlight
- ◆ Resolution 800*480
- ◆ Memory 128MB
- ◆ Two serial ports
Download port: RS232, RS485
PLC port: RS232, RS485, RS422
- ◆ Model explanation:
MT: USB-B port
UT: USB-A port, USB-B port
ET: USB-A port, USB-B port, Ethernet port

4.3 inches
TG465-XT/MT/UT/ET/MT2/UT2



- ◆ 16.77 million colors, TFT LCD, LED backlight
- ◆ Resolution 480*272
- ◆ Memory 128MB
- ◆ XT: one serial port
PLC port: RS232, RS485
- ◆ MT/UT/ET: one serial port
PLC port: RS232, RS485, RS422
- ◆ MT2/UT2: 2 serial ports
PLC port: RS232, RS485, RS422
Download port: RS232, RS485
- ◆ Model explanation:
XT/MT/MT2: USB-B port
UT/UT2: USB-A port, USB-B port
ET: USB-A port, USB-B port, Ethernet port

Fashionable model - TG765S, TGA63S series

Ultra-thin appearance, the thickness is only 38.5mm. The cover is made of PC and ABC alloy, more sturdy and durable. The installation bayonet is sealed to prevent from dust and oil. The communication port is at the bottom, saving the installation space.

New fashionable appearance, better visual effect, comfortable touch feeling, the cover is made of PC and ABC alloy, more sturdy and durable. The installation bayonet is sealed to prevent from dust and oil, prolonging the service life.

7 inches
TG765S-MT/UT/ET



- ◆ 16.77 million colors, TFT LCD, LED backlight
- ◆ Resolution 800*480
- ◆ Memory 128MB
- ◆ Two serial ports
Download port: RS232, RS485
PLC port: RS232, RS485, RS422
- ◆ Model explanation:
MT: USB-B port
UT: USB-A port, USB-B port
ET: USB-A port, USB-B port, Ethernet port

10.1 inches
TGA63S-MT/UT/ET



- ◆ 16.77 million colors, TFT LCD, LED backlight
- ◆ Resolution 1024*600
- ◆ Memory 128MB
- ◆ Two serial ports
Download port: RS232, RS485
PLC port: RS232, RS485, RS422
- ◆ Model explanation:
MT: USB-B port
ET: USB-A port, USB-B port, Ethernet port

Economical model - TG765-XT-C, TG765S-XT series

Based on advanced model TG765, has one RS232 port.

Based on TG765S, has two RS232 ports and real-time clock.

7 inches
TG765-XT-C



- ◆ 16.77 million colors, TFT LCD, LED backlight
- ◆ Resolution 800*480
- ◆ Memory 128MB
- ◆ PLC port: RS232
- ◆ Model explanation:
XT-C: real-time clock

7 inches
TG765S-XT



- ◆ 16.77 million colors, TFT LCD, LED backlight
- ◆ Resolution 800*480
- ◆ Memory 128MB
- ◆ Two serial ports
Download port: RS232
PLC port: RS232
- ◆ Model explanation:
XT: USB-B port, real-time clock

Normal model - TH series

Standard model with basic functions, the size includes 4.3 to 10.4 inches.

10.4 inches
THA65-MT/UT



- ◆ 65536 colors, TFT LCD, LED backlight
- ◆ Resolution 800*600
- ◆ Memory 128MB
- ◆ Two serial ports
Download port: RS232, RS485
PLC port: RS232, RS485, RS422
- ◆ Model explanation:
MT: USB-B port
UT: USB-A port, USB-B port

10.1 inches
THA62-MT/UT



- ◆ 65536 colors, TFT LCD, LED backlight
- ◆ Resolution 800*480
- ◆ Memory 128MB
- ◆ Two serial ports
Download port: RS232, RS485
PLC port: RS232, RS485, RS422
- ◆ Model explanation:
MT: USB-B port
UT: USB-A port, USB-B port

8 inches
TH865-MT/UT



- ◆ 65536 colors, TFT LCD, LED backlight
- ◆ Resolution 800*600
- ◆ Memory 128MB
- ◆ Two serial ports
Download port: RS232, RS485
PLC port: RS232, RS485, RS422
- ◆ Model explanation:
MT: USB-B port
UT: USB-A port, USB-B port

7 inches
TH765-MT/UT/N/NU



- ◆ 65536 colors, TFT LCD, LED backlight
- ◆ Resolution 800*480
- ◆ Memory 128MB
- ◆ Two serial ports
Download port: RS232, RS485
PLC port: RS232, RS485, RS422
- ◆ Model explanation:
MT/N: USB-B port
UT/NU: USB-A port, USB-B port

7 inches
TH765-N3/NU3



- ◆ 65536 colors, TFT LCD, LED backlight
- ◆ Resolution 800*480
- ◆ Memory 128MB
- ◆ Three serial ports
Download port: RS232, RS485
PLC port: RS232, RS485, RS422
Extension port: RS485 (extend from download port 1A6B)
- ◆ Model explanation:
N3: USB-B port
NU3: USB-A port, USB-B port

4.3 inches
TH465-MT/UT/MT2/UT2



- ◆ 65536 colors, TFT LCD, LED backlight
- ◆ Resolution 480*272
- ◆ Memory 8MB
- ◆ MT/UT: one serial port
PLC port: RS232, RS485, RS422
- ◆ MT2/UT2: two serial ports
Download port: RS232
PLC port: RS232, RS485, RS422
- ◆ Model explanation:
MT/MT2: USB-B port
UT/UT2: USB-A port, USB-B port



Oil proof model

Model Dimension	TH series oil proof model	TG series oil proof model	TE series oil proof model
4.3 inches	TH465-MT(P) TH465-UT(P)	TG465-MT(P) TG465-UT(P)	
7 inches	TH765-NT(P) TH765-NU(P)	TG765-MT(P) TG765-UT(P) TG765-ET(P) TG765-XT(P)-C	TE765-MT(P) TE765-UT(P) TE765-ET(P)
8 inches	TH865-MT(P) TH865-UT(P)	TG865-MT(P) TG865-ET(P)	
10.1 inches	THA62-MT(P) THA62-UT(P)	TGA62-MT(P) TGA62-ET(P)	



Oil proof model with suffix P re-design the cover and film. The film back adhesive tape width increased to prevent from the oil. Other functions are the same. The models are fit for the heavy oil environment.

Operate panel - OP/MP series

OP/MP series HMI has compact size and delicate appearance

- 3.7 inches, STN LCD, resolution 192*64, memory 64KB.
- User-defined function buttons, replace the machine button.
- Support most PLC brands in the market.
- Alarm, password, clock, bmp picture display, screen switching by PLC.
- MP series display area can be touched.

3.7 inches
OP320/OP320-S

- ◆ 7 buttons
- ◆ Without clock
- ◆ One communication port
OP320: RS232, RS422
OP320-S: RS232, RS485

3.7 inches
OP320-A/OP320-A-S/
OP320-A-N

- ◆ 20 buttons
- ◆ With clock
- ◆ One communication port
OP320-A: RS232, RS422
OP320-A-S: RS232, RS485
OP320-A-N: RS232

3.7 inches
OP325-A/OP325-A-S

- ◆ 20 buttons
- ◆ With clock
- ◆ One communication port
OP325-A: RS232, RS422
OP325-A-S: RS232, RS485

3.7 inches
OP330/OP330-S

- ◆ 26 buttons
- ◆ With clock
- ◆ One communication port
OP330: RS232, RS422
OP330-S: RS232, RS485

3.7 inches
MP325-A/MP325-A-S

- ◆ 20 buttons
- ◆ With clock
- ◆ One communication port
MP325-A: RS232, RS422
MP325-A-S: RS232, RS485

3.7 inches
MP330/MP330-S

- ◆ 26 buttons
- ◆ With clock
- ◆ One communication port
MP330: RS232, RS422
MP330-S: RS232, RS485

Hardware features

- **DIP switch:**
DIP2: forced download.
DIP3: set system clock, adjust the touch area.
- **Power supply interface:**
24V DC power supply.
- **Serial port:**
TG/TE/TH series
PORT1 (Download) : RS232/RS485.
PORT2 (PLC) : RS232/RS485/RS422.
Extension port: RS485 (only TH765-N3/NU3 support)
-NT series
PORT1 (Download) : RS232/RS485/RS422.
PORT2 (PLC) : RS485.
- **USB-A port:**
connect flash disk to export and import data (characters and data), download program(TG/TE series support, the version must be v2.d3c and up).
- **USB-B port:**
download and upload program.
- **Ethernet port:**
ET, NT series, remote monitoring, data exchanging, networking based on Ethernet. Support pass through function.

Model explanations
 MT: USB-B port.
 UT: USB-A port, USB-B port.
 ET: USB-A port, USB-B port, Ethernet port.
 NT: USB-A port, USB-B port, Ethernet port.

Powerful communication ability

Flexible connectivity, can communicate with multi-device

- Can connect most PLC brands such as Mitsubishi, Siemens, Omron, Schneider and frequency inverter such as Delta, Yaskawa.
- Can communicate with Modbus protocol devices, can connect more than one devices at the same port such as PLC, frequency inverter, servo drive, meter.
- Support free format communication, make program with C language to communicate with various meters.



Support micro printer

- The download port can connect micro needle printer, panel printer, thermal printer. It can real-time print the project data and curve.



Various networking mode

Networking as master-slave mode or X-NET fieldbus.

● One HMI and multi-device



● Multi-HMI and one device

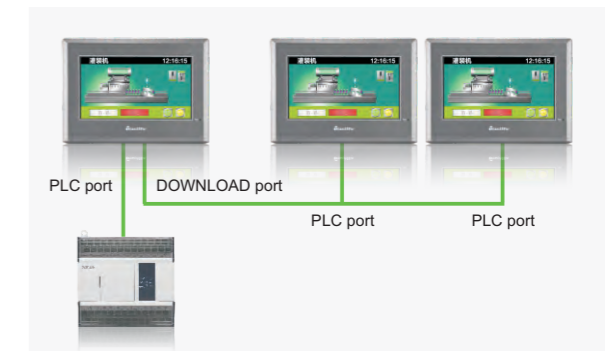

● Multi-HMI and multi-device

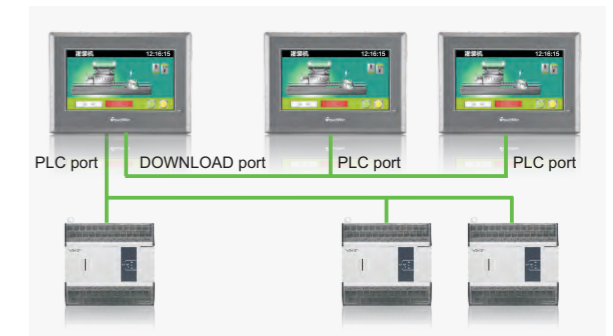

High speed transmission with humanized port

Humanized front USB-A port

- USB-A port can export and import the data. This port is in the front of the cover. It no needs to open the control cabinet when sending the data, easy to operate, improve the working efficiency.



Program download based on USB-B port

- USB-B port accords to USB2.0 standard. The port connects PC through USB cable and high speed downloads the program. It saves the downloading time and easy to debug the program.

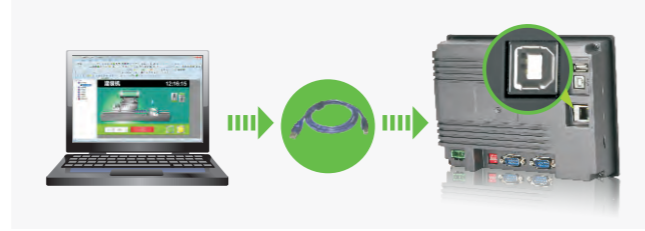

Free installation mode

- To choose vertical or horizontal installation according to the scene condition (TG/TE series)



Touchwin software

C function block is equal to anything including calculation, command, communication

C function block makes the HMI fit for complicated calculation and communication, improves the system performance.

- Support most C functions

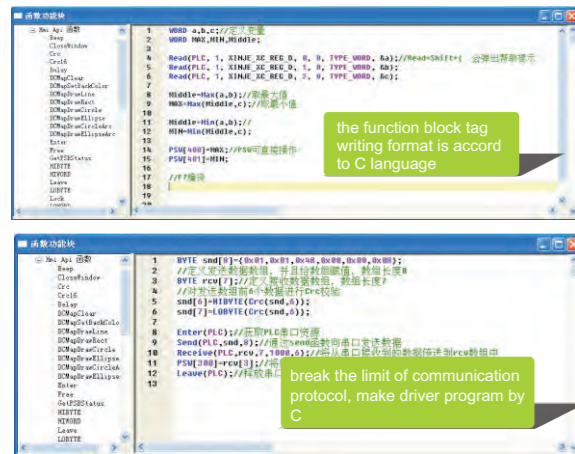

- The C program can be encrypted, user can open the program after inputting the password

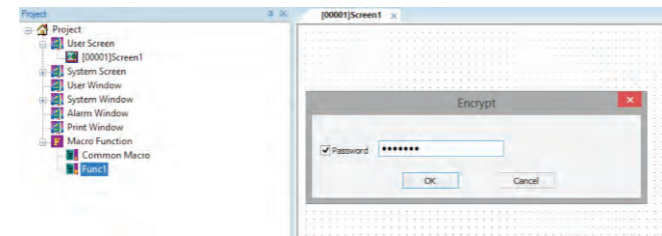

Screen saver

PSB8=1, HMI will be in screen saver mode, PSB8=0, HMI will exit screen saver mode.

Support QR code generation and display (TG/TE series)

- Set the QR code contents

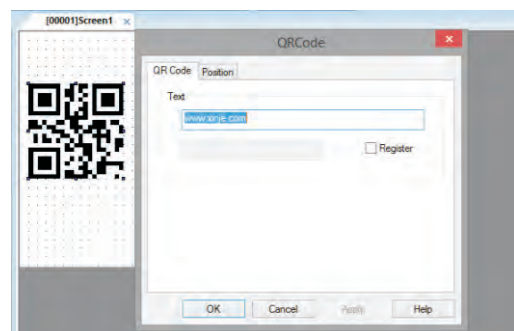

- Dynamic set the QR code contents through registers

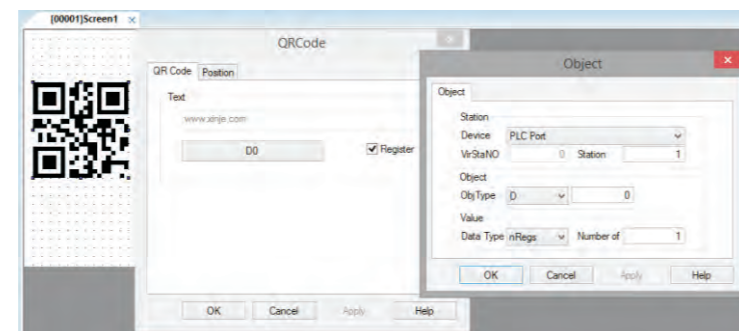

The user screen can be saved as picture

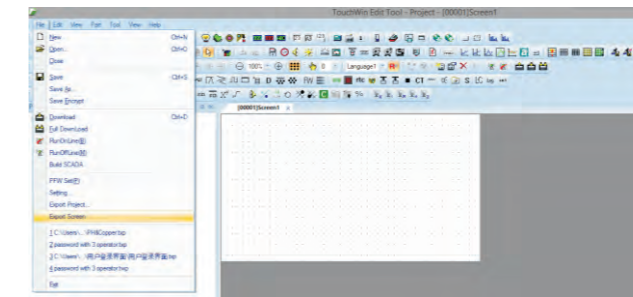

Powerful visual expressive brings new feeling

Rich 3D picture library and element resources

- The picture library has rich icons including meter, valve, pipe, fan, pump, motor, etc.
- Design the icon with the drawing element including line, rectangle, ellipse, broken line, polygon, three dimensional frame.
- Support bmp, jpg and png format picture import.
- Bar graph and cylindrical graph.

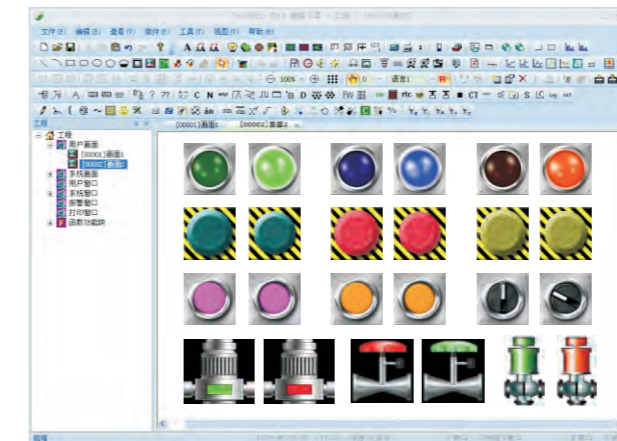

Support multi-language, easy to switch

- Use standard characters corresponding to Unicode character library.
- Switch the language through PFW101.
- Support 8 kinds of language switching online.

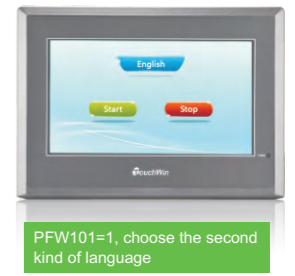
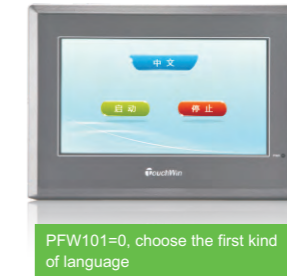

Various fonts and language

- Windows graph font input.
- Support Chinese, English, Japanese, Russian and so on.
- Support any fonts, size, bold, italic, underline.
- Support art effect, projection, stroke, fill.
- Support rolling words, twinkling, dynamic text.



Powerful data processing ability

Process control data acquisition, the trend graph is more visual

- Various graph displaying: real-time trend graph, historical trend graph, time trend graph, XY trend graph, XY curve graph, bar graph.
- Zoom in and out, page up and down, clear the curve with data moving button.
- Read detailed data at certain time with general table and data table.

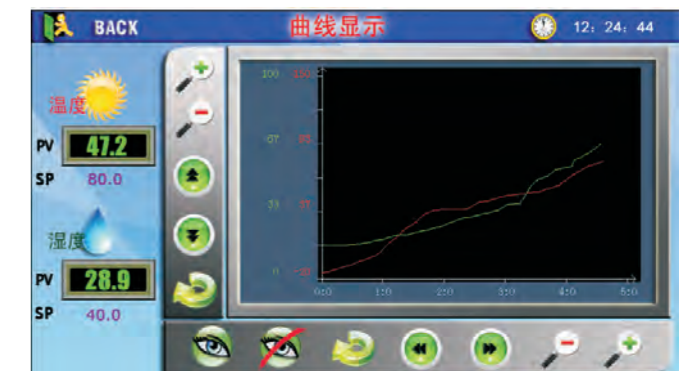

Half the time to make the program

- Batch set the font, size, shape of text in different places.
- Batch copy all the components, can set the vertical or horizontal space of communication address, row numbers, row pitch, column numbers, column pitch.
- Display all the component communication address, no need to check each component feature.
- Support picture rotation 90°, 180°, 270°.
- Support unlimited times of undo (Ctrl+Z) and recover (Ctrl+Y) operations.
- The picture settings support equal width, height, size, vertical distance, horizontal distance.
- Ratio transformation for data input and display.
- C programming has function library and examples.

New animation editing mode, rich performance

- Easy animation editing mode, user-defined movement track.
- Support translation and rotation animation, close connection, smooth screen.

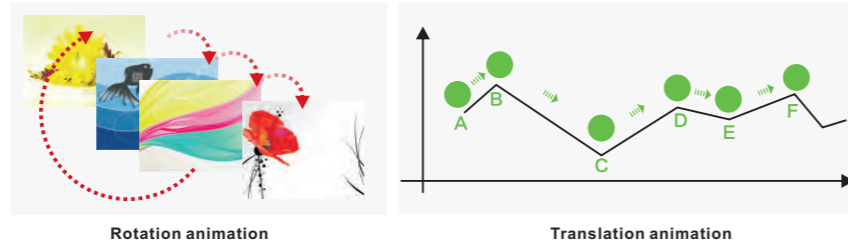

Import program via USB-A port with flash disk

TG/TE series –UT/ET/NT model have USB-A port, which can import the program in the HMI with flash disk but no need PC. The download process is easy and fast. The program is encrypted, it is fit for program updating without download cable and PC. (the HMI version must be v2.d3c and up)

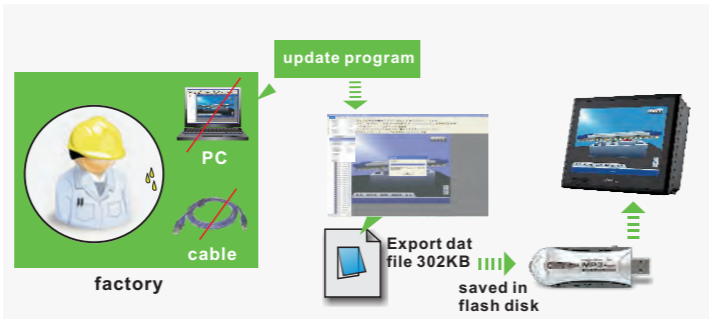

Export the csv file from Flash-disk, backup the important data

Export and import the historical data, recipe data, curve data in csv format by Flash-disk. The file can be opened in Excel. Support many kinds of hexadecimal and characters..

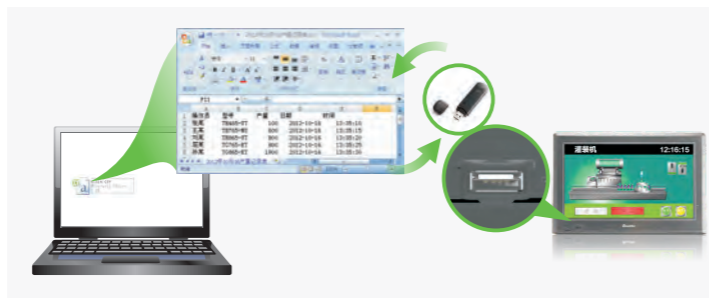

The storage and bidirectional transmission of recipe data improve the working efficiency

The HMI can store large amounts of data. Manual inputting parameters every time will influence the working efficiency for various types of production.

Storing the data in the HMI and bidirectional transfer the data in csv format through Flash-disk. It can manage different types of information and improve the efficiency.

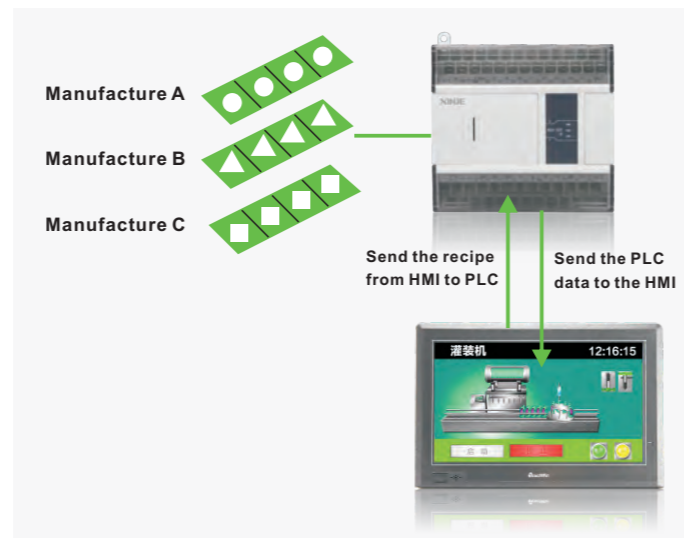

Perfect encryption function

Nine levels of password, user-defined authority setting

- Protect the authority through the password.
- The password level defines the operation authority.

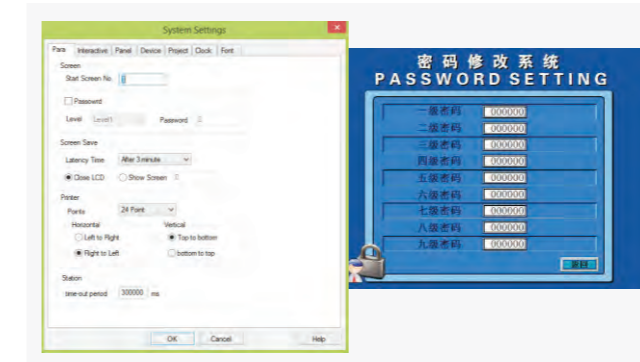

Program encryption

- The software can export the encryption file in txp format. When this file is opened, the program is invisible but can be downloaded in the HMI through Touchwin software. The programmer needs to save another backup for this application.

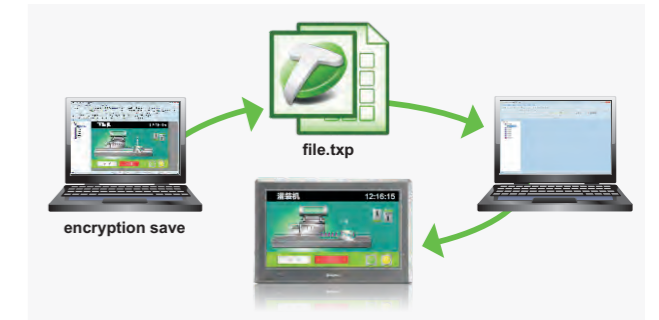

The alarm function can fast recover the system

- Alarm list, alarm window and calling window can help user to find the error and recover the system.
- The historical event can show the historical alarm information.
- The list can page up and down, clear with data moving button.

Buzzer alarm

- The alarm list and window has buzzer function. The buzzer mode including silent, ring once, continuous ringing.



Manually close the backlight

- When PSB9 is ON, the backlight is off and enter the screen saver.

Buzzer sound

- PFW2=0, the buzzer has sound, PFW2=1, the buzzer has no sound. Repower on the HMI to make the setting effective. The default value is 0.

X-NET fieldbus TG/TE/TG(P)/TE(P) supported

- The download port of slave machine can be used.
- The speed can up to 3M, the communication has no delay.
- Can communicate with XD series PLC.
- The system wiring diagram please refer to XD.
- TG/TE/TG(P)/TE(P) support X-NET fieldbus OMMS mode; -NT model support X-NET fieldbus OMMS and TBN mode..



Product specification

Advanced model - TG/TE series

Specification	TGC65 series		TGA63 series		TGA62 series		TG865 series		TG765/TE765 series		TG765(S)-XT series		TG465 series	
	TGC65-ET	TGA63-MT/UT/ET/NT TGA63S-MT/UT/NT	TGA62-MT/ET	TG865-MT/ET/NT	TG765-MT/UT/ET/NT TG765S-MT/UT/ET	TG765-XT-C	TG765S-XT	TG465-MT/MT/ UT/ET/MT2/UT2						
Dimension(inch)	15.6	10.1	10.1	8	7	7	7	4.3						
Resolution	1366*768	1024*600	800*480	800*600	800*480	800*480	800*480	480*272						
LCD	TFT LCD, LED backlight													
Color	16.77 million true colors													
Bright	250	200												
Touch panel	4-wire resistor touch screen													
LCD life	Above 50000 hours, ambient temperature 25°C, 24 hours running													
Memory	128MB							8MB						
PLC port	RS232/RS422/RS485 (-NT series is RS485)					RS232	RS232	RS232/RS485/ RS422 -XT support RS232/RS485						
Download port	RS232/RS485 (-NT series is RS232/RS485/RS422)					\	RS232	RS232/RS485 (only -MT2/UT2 supported)						
USB port1	USB-B (USB 2.0 standard), USB download port													
USB port2	USB-A (USB 2.0 standard), Flash-disk port, UT/ET model supported													
Ethernet	ET model supported					\	\	ET model supported						
Input voltage	DC24V (voltage range: DC22V~26V)													
Consumption current	730mA	270mA	270mA	250mA	200mA	200mA	180mA							
Allowable power-off	1Under 10ms (actual power-off is less than 1s)													
Voltage shock endurance	AC1000V, 10mA less than 1 minute													
Insulation resistance	Above 10MΩ, DC500V													
Operating temperature	0~50°C													
Storage temperature	-20°C ~ 60°C													
Operating humidity	10%RH~90%RH (no condensation)													
Anti-interference ability	Interference voltage: 1500 Vp-p, pulse period: 1μs, duration time: 1 minute													
Ambient	No corrosive gas													
Cooling mode	Natural cooling													
Protection level	IP65 for front cover													
Dimension (mm)	410.0*270.0*65.0	272.2*191.7*51.2	272.2*191.7*51.2	224.4*170.8*45.5	200.4*146.9*48.5	200.4*146.9*48.5	205.4*146.5*38.5	152.0*102.0*41.8						
Mounting dimension (mm)	399.0*259.0	260.2*179.7	260.2*179.7	211.4*157.8	192.0*138.5	192.0*138.5	192.0*138.5	144.0*94.0						

* Note: all the models have clock, TG765S-MT/UT/ET dimension is 205.4*146.5*38.5mm. TE765 series include MT/UT/ET model.

Basic model - TH series

Specification	THA65 series		THA62 series		TH865 series		TH765-M series		TH765-N series		TH465 series	
	THA65-MT/UT	THA62-MT/UT	TH865-MT/UT	TH765-MT/UT	TH765-N/NU/N3/NU3	TH465-MT/UT/MT2/UT2						
Dimension(inch)	10.4	10.1	8	7	7	4.3						
Resolution	800*600	800*480	800*600	800*480	800*480	480*272						
LCD	TFT LCD, LED backlight											
Color	65536 true colors											
Bright	200											
Touch panel	4-wire resistor touch screen											
LCD life	Above 50000 hours, ambient temperature 25°C, 24 hours running											
Memory	128MB					8MB						
PLC port	RS232/RS422/RS485											
Download port	RS232/RS485					RS232 (MT2/UT2 supported)						
USB port1	USB-B (USB 2.0 standard), USB download port											
USB port2	USB-A (USB 2.0 standard), Flash-disk port, UT/UT2/NU/NU3 model supported											
Ethernet	Not supported											
Expansion	Not supported			RS485 (N3/NU3 supported)		Not supported						
Input voltage	DC24V (voltage range: DC22V~26V)											
Consumption current	630mA	230mA	260mA	250mA	250mA	130mA						
Allowable power-off	Under 10ms (actual power-off is less than 1s)											
Voltage shock endurance	AC1000V, 10mA less than 1 minute											
Insulation resistance	Above 10MΩ, DC500V											
Operating temperature	0°C ~ 50°C											
Storage temperature	-20°C ~ 60°C											
Operating humidity	10%RH~90%RH (no condensation)											
Anti-interference ability	Interference voltage: 1500 Vp-p, pulse period: 1μs, duration time: 1 minute											
Ambient	No corrosive gas											
Cooling mode	Natural cooling											
Protection level	IP65 for front cover											
Dimension (mm)	311.0*234.0*48.0	272.2*191.7*51.2	224.4*170.8*45.5	204.0*150.5*43.9	204.0*150.5*43.9	152.0*102.0*41.8						
Mounting dimension (mm)	303.0*225.0	260.2*179.7	211.4*157.8	192.0*138.5	192.0*138.5	144.0*94.0						

Oil proof model- TG(P)/TE(P)/TH(P)

Specification	TGA62(P) series		TG865(P) series		TG/TE765(P) series		TG765-XT(P) series		TG465(P) series		THA62(P) series		TH865(P) series		TH765(P) series		TH465(P) series	
	TGA62-MT(P) TGA62-ET(P)	TG865-MT(P) TG865-ET(P)	TG/TE765-MT(P) TG/TE765-UT(P) TG/TE765-ET(P)	TG765-XT(P)-C	TG465-MT(P) TG465-UT(P)	THA62-MT(P) THA62-UT(P)	TH865-MT(P) TH865-UT(P)	TH765-NT(P) TH765-NU(P)	TH465-MT(P) TH465-UT(P)									
Dimension(inch)	10.1	8	7	7	4.3	10.1	8	7	4.3									
Resolution	800*480	800*600	800*480	800*480	480*272	800*480	800*600	800*480	480*272									
LCD	TFT LCD, LED backlight																	
Color	16.77 million true colors				65536 true colors													
Bright	200																	
Touch panel	4-wire resistor touch screen																	
LCD life	Above 50000 hours, ambient temperature 25°C, 24 hours running																	
Memory	128MB							8MB										
PLC port	RS232/RS422/RS485				RS232		RS232/RS422/RS485		\									
Download port	RS232/RS485				\		\		RS232/RS485		\							
USB port1	USB-B (USB 2.0 standard), USB download port																	
USB port2	USB-A (USB 2.0 standard), Flash-disk port, UT(P)/NU(P)/ET(P) model supported																	
Ethernet	ET(P) model supported				\		Not supported											
Input voltage	DC24V (voltage range: DC22V~26V)																	
Consumption current	270mA	250mA	200mA	200mA	180mA	230mA	260mA	250mA	130mA									
Allowable power-off	Under 10ms (actual power-off is less than 1s)																	
Voltage shock endurance	AC1000V, 10mA less than 1 minute																	
Insulation resistance	Above 10MΩ, DC500V																	
Operating temperature	0~50°C																	
Storage temperature	-20°C ~ 60°C																	
Operating humidity	10%RH~90%RH (no condensation)																	
Anti-interference ability	Interference voltage: 1500 Vp-p, pulse period: 1μs, duration time: 1 minute																	
Ambient	No corrosive gas																	
Cooling mode	Natural cooling																	
Protection level	IP65 for front cover																	
Dimension (mm)	272.2*191.7*51.2	224.4*168.7*45.0	200.4*146.9*48.5	200.4*146.9*48.5	152.0*102.0*41.8	272.2*191.7*51.2	224.4*168.7*45.0	200.4*146.9*48.5	152.0*102.0*41.8									
Mounting dimension (mm)	260.2*179.7	211.4*157.8	192.0*138.5	192.0*138.5	144.0*94.0	260.2*179.7	211.4*157.8	192.0*138.5	144.0*94.0									

OP series product specification

Model	OP330/-S	MP330/-S	OP325-A/-A-S	MP325-A/-A-S	OP320-A/-A-S	OP320-A-N	OP320/-S
Display							
Type	Kelly STN			Blue STN		Kelly STN	
Using life	Above 20000 hours, ambient temperature 25°C, 24 hours running						
Resolution	192*64						
Contrast	Adjust by potentiometer						
Character	Chinese, English						
Character size	Chinese: 16*16 32*32 English: 8*16 16*32						
Button	26		20			7	
Memory							
Screen	64KB FlashROM						
Interface							
Download port	RS232						
Communication port	Normal models support RS232/RS422, (-S) models support RS232/RS485, OP320-A-N support RS232						
Electric feature							
Input voltage	DC24V						
Voltage range	DC22V~26V						
Consumption current	<140mA						
Allowable power-off	Under 10ms (actual power-off less than 1s)						
Voltage shock endurance	AC1000V, 10mA less than 1 minute						
Insulation resistance	Above 10MΩ, DC500V						
Environment							
Operating temperature	0°C ~ 50°C						
Storage temperature	-20°C ~ 60°C						
Operating humidity	10%RH~90%RH (no condensation)						
Anti-interference ability	Interference voltage: 1500 Vp-p, pulse period: 1μs, duration time: 1 minute						
Ambient	No corrosive gas						
Cooling mode	Natural cooling						
Protection level	IP65 for front cover						
Structure							
Dimension (mm)	172.0*121.0*56.5		172.0*94.0*38.8		172.0*94.0*30.0		162.0*102.0*38.0
Mounting dimension (mm)	164.0*113.0		164.2*86.8		164.2*85.0		156.5*94.0

*Note: OP320/OP320-S have no clock, other models have clock.

Product dimension (unit: mm)

TGC65-ET

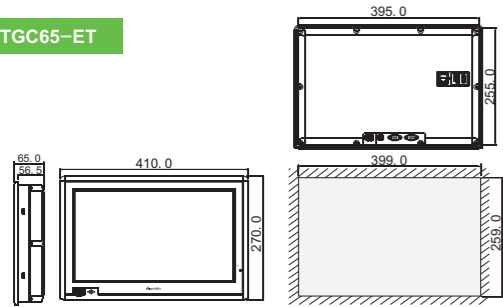

THA65-MT/UT

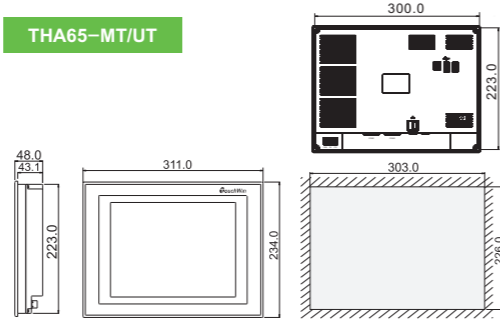

TG465-XT/MT/UT/ET

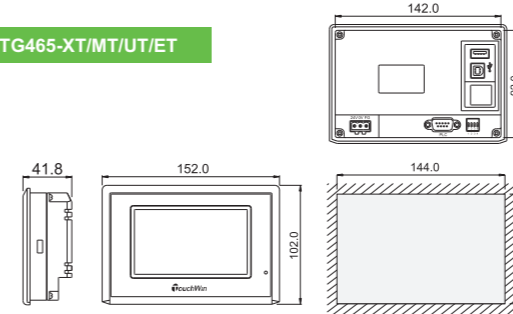

TG465-MT2/UT2
TH465-MT2/UT2

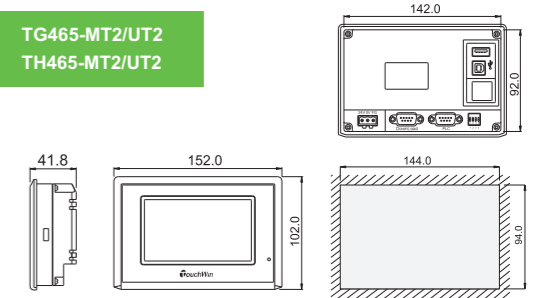

TGA63-MT/UT/ET/NT

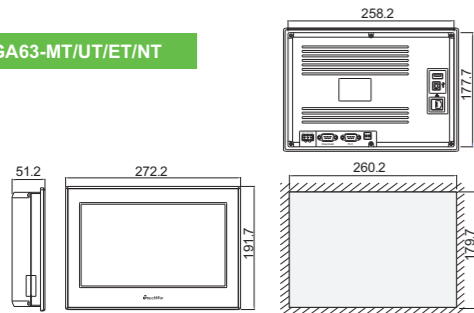

TGA62-MT/ET
THA62-MT/UT

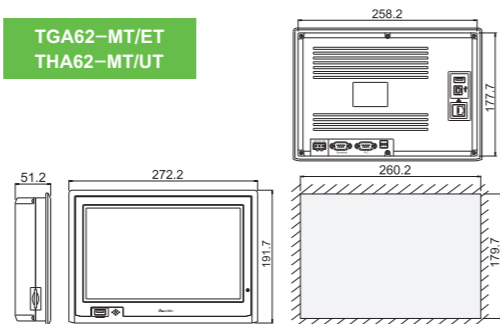

TGA62-MT(P)/ET(P)
THA62-MT(P)/UT(P)

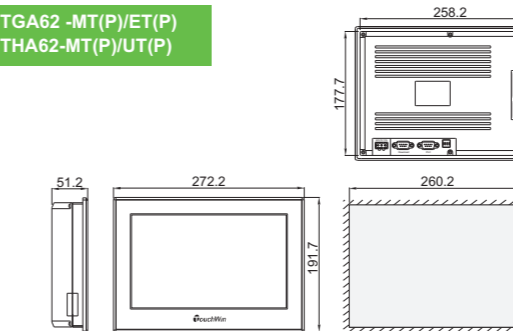

TG865-MT(P)/ET(P)
TH865-MT(P)/UT(P)

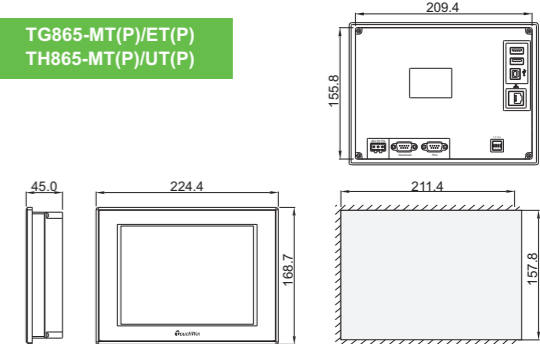

TGA63S-MT/UT/ET

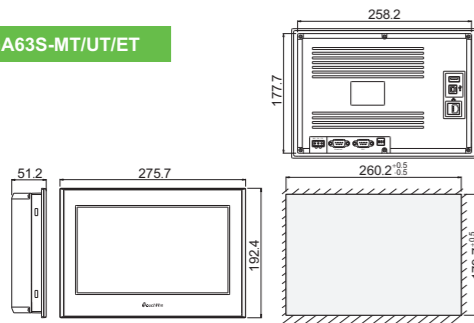

TG865-MT/ET/NT
TH865-MT/UT

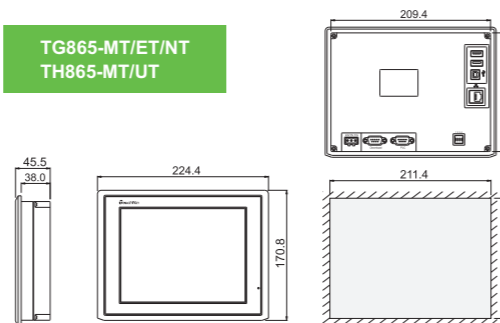

TG765-MT(P)/UT(P)/ET(P)
TE765-MT(P)/UT(P)/ET(P)
TH765-NT(P)/NU(P)

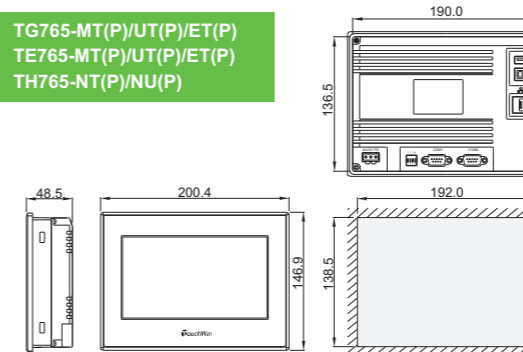

TG765-XT(P)-C

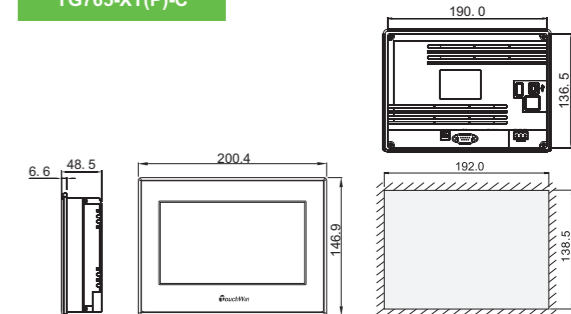

TG765-MT/UT/ET/NT
TE765-MT/UT/ET

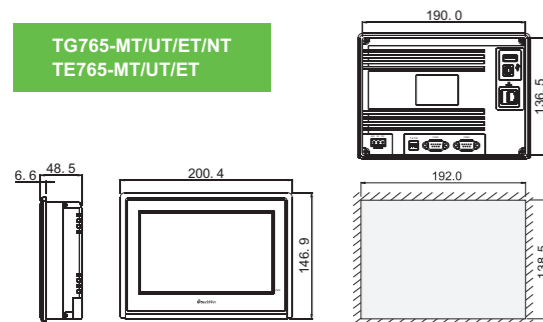

TG765-XT-C

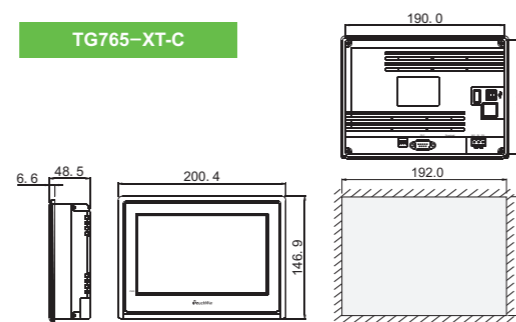

TG765S-XT/MT/UT/ET

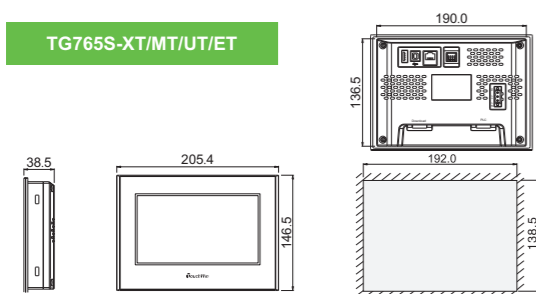

TH765-MT/UT
TH765-N/NU/N3/NU3

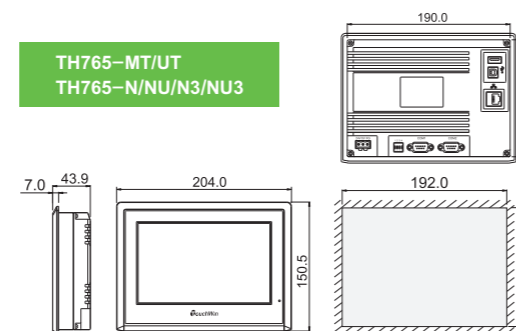

TG465-MT(P)/UT(P)
TH465-MT(P)/UT(P)

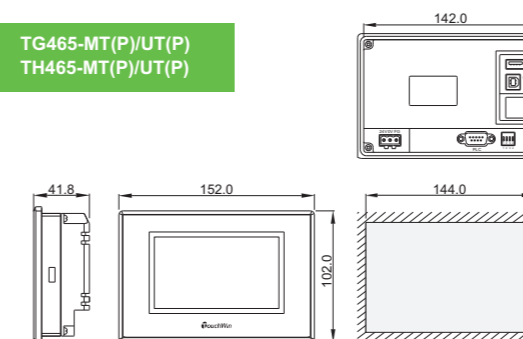

OP325-A/OP325-A-S/MP325-A/MP325-A-S

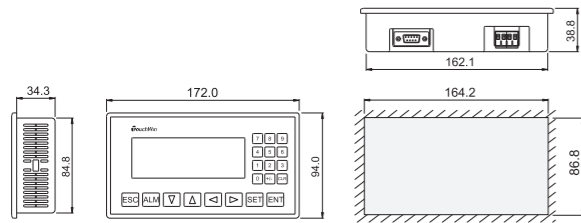

OP330/OP330-S/MP330/MP330-S

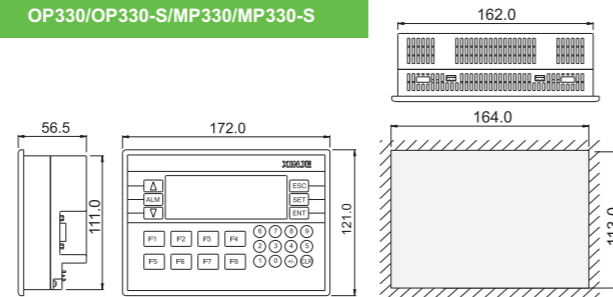

OP320/OP320-S

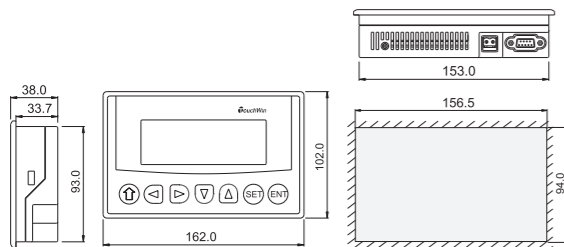

OP320-A/OP320-A-N/OP320-A-S

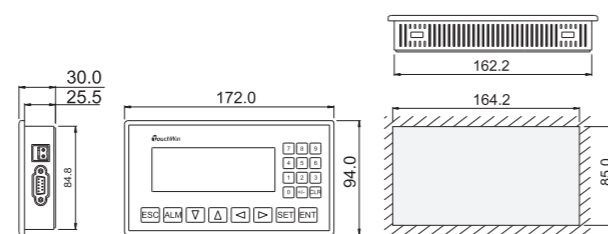

Integrated PLC &HMI controller Rich product models

ZG series
ZP series
XMH series
XMP series
XP series

- Integrate PLC and HMI in one unit.
- High speed data transmission and program downloading based on USB port.
- User-defined cover mask fits for different needs.
- Flexible expansion function, ZP/XMH series can connect two BD boards.
- Rich screen display and picture library, support all the functions of HMI.



High performance and complete functions

Two-in-one functions bring new experience

- ZGM-30T4-7 = XDM-30T4 + TG765
- ZG3-30R/T/RT-7 = XD3-32R/T/RT + TG765
- ZP3-18T=XD3-18T + OP331
- XMH3-30 = XC3-30 + TH765
- Integrate logic control and HMI in one unit
- The display area is touch screen, easier to control



Integrated structure, perfect combination of PLC and HMI

Integrated structure, save mounting space

- Multi-functional programming port: download PLC and HMI program with the same cable except ZG and XMH series.



Compact structure, save the space of electrical cabinet



Flexible extension function (can extend 2 BD boards)

Integrated structure, save mounting space

- ZP3-18, XMH3-30 can meet more needs of analog and temperature control; support 2 BD boards, the BD board type up to 5 (ZP3-18 supported 2 types of Z series BD, XMH3-30 supported 5 types of XP-BD2 series BD)
- Other models supported 1 BD board.



Powerful data backup function, user-friendly interface

Data import and export based on USB port

XMH3-30 has USB-A port on the front and back side which is used to backup the data, especially designed for the field data collection and storage, data export and import. The maintenance and checking of project data are more effective through csv format file.

- USB-A port is accord to USB2.0 standard, the USB cable can transfer the data at high speed and save the downloading time.



Panel design closes to user needs

Multi-functional panel buttons with panel LED (XMH series)

- 8 function buttons can be set to any functions, the buttons are sensitive and precise.
- The panel has power LED, easy to command the machine running state.



Display

Vivid display and picture library, support all the HMI functions

- True color LCD, XPG series is 16.77 million colors, XMH series is 65536 colors.
- 7 inches screen, more displaying contents and vibrant colors.
- 128MB FlashROM fits for large project making.

3D picture library brings new visual experience

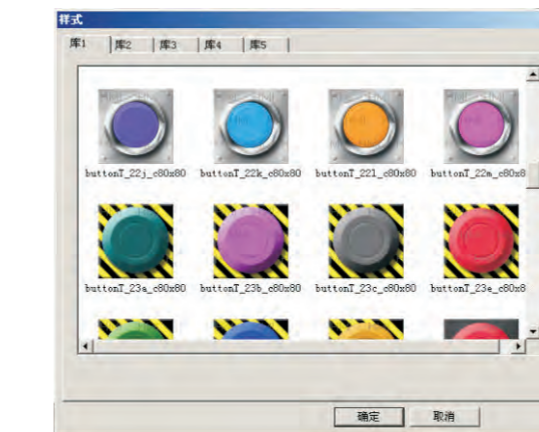

Enhanced alarm function enables the user to solve process problem quickly

- The flexible setting of alarm list and alarm window helps the user to find the problem and shorten the machine downtime, fast recover the system.



Fit for different project needs

- The button mask can be changed.



New animation editing mode, rich performing format

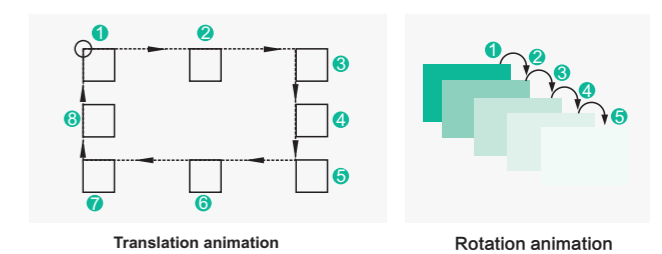

Process control and data acquisition functions, the trend graph is more visually



Communication

Two communication ports, connect all kinds of devices quickly

- **Download port:** download/upload PLC and HMI program (ZGM-30T4, ZG3-30 and XMH3-30 can download/upload HMI program via USB-B port).
- **Communication port:** PLC can communicate with other devices via RS232 or RS485.



Control

ZGM-30 uses the chip of XDM series PLC, has 4 channels of pulse output

ZG3-30 has the chip of XD3 series PLC, with richer PLC functions, other models have the chip of XC3 series PLC

- The 32-bit high speed counter frequency can up to 80KHz
- 2 to 4 channels of 200KHz high speed pulse output

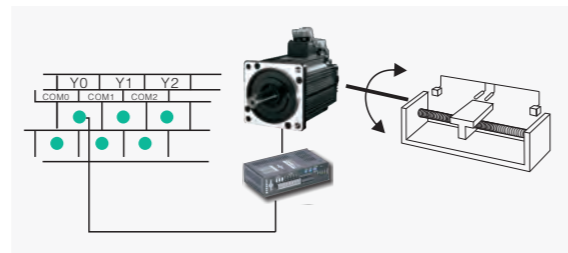
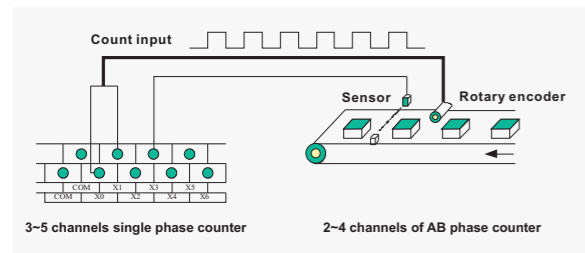

Configuration table

Specification	product	XP series			XMP series	XMH series	ZG series	ZGM series	
		XP1-18R/T/RT-C	XP2-18R/T/RT-C	XP3-18R/T/RT-C	XMP2-32R/T/RT-E	XMH3-30R/T/RT-E	ZG3-30R/T/RT-7	ZGM-30T4-7	
Structure	HMI	OP330(XP)			MP760-T(XMP-32)	B/MH765-M(XB/MH-30)	TG765-MT/UT/ET/XT	TG765-MT/UT/ET/XT	
	PLC	XC1-18R/T/RT	XC2-18R/T/RT	XC3-18R/T/RT	XC2-32R/T/RT	XC3-32R/T/RT	XD3-32R/T/RT	XDM-32T	
Electric features	Input voltage	DC24V (voltage range: DC22V~DC26V)			AC220V (voltage range: AC100V~240V)		DC24V (voltage range: DC22V~DC26V)	DC24V (voltage range: DC22V~DC26V)	
	Interface	RS232 (download/upload PLC program, download OP program)			/	RS232 (download/upload PLC program, PLC port1)			
Interface	Com1	/	/	/	RS232 (download/upload PLC/HMI program)	RS232 (PLC port2)	/	/	
	Com2	/	/	/	RS232 (PLC port2)	/	/	/	
	AB terminal	/	/	/	RS485 (PLC port2)			/	
	USB port1	/	/	/	USB-B, download/upload HMI program			/	
Screen features	USB port2	/	/	/	/	USB-A, Flash-dish port	/	/	
	Type	Blue LCD			256 colors		65536 colors	16.77 million colors	16.77 million colors
	LCD	3.7 inches			7 inches		7 inches		
PLC features	Touch mode	Cannot touch			Matrix touch mode		4-wire resistor touch mode		
	Programming mode	Instruction, ladder chart, C language							
	Processing speed	0.3us			0.5us	0.3us	0.05us	0.05us	
	I/O numbers	Input 10, output 8			Input 16, output 16		Input 16, output 14		
	High speed processing	High speed count, pulse output, external interruption							
Self-diagnosis	6-bit ASCII								
Self-diagnosis	Power-on self-checking, monitor timer, grammar checking								

Specification	product	ZP3 series	
		ZP3-18T	
Structure	HMI	OP331	
	PLC	XD3-18T	
Electric features	Input voltage	DC24V (voltage range: DC22V~DC26V)	
	Com0	RS232 (download/upload PLC program, download OP program)	
Interface	Com1	/	
	Com2	/	
	AB terminal	RS485 (PLC port2)	
	USB port1	/	
Screen features	USB port2	/	
	Type	Blue LCD	
	LCD	3.7 inches	
PLC features	Touch mode	Cannot touch	
	Programming mode	Instruction, ladder chart, C language	
	Processing speed	0.05us	
	I/O numbers	Input 10, output 8	
	High speed processing	High speed count, pulse output, external interruption	
Self-diagnosis	6-bit ASCII		
Self-diagnosis	Power-on self-checking, monitor timer, grammar checking		

Dimension (unit: mm)

